



► FROM PENTAIR WATER SOLUTIONS

## 2026 PRICE LIST - AMERICAS

SUGGESTED LIST PRICES  
STANDARD EQUIPMENT AND ACCESSORIES



Effective April 1, 2026

ENGINEERED **FOR EASE**

## TABLE OF CONTENTS

Cube Ice Machines . . . . .	3-9	Dispensers . . . . .	18
Standard Remotes and Top Air Discharge . . . . .	10	Ice Storage Bins . . . . .	19-20
QuietQube® Remotes & Ice Beverage. . . . .	11-12	International Only. . . . .	21
Specialty: Prison and Marine. . . . .	13	Bin Adapters & Deflector Kits . . . . .	22-23
Flake Ice Machines . . . . .	14-15	Accessories . . . . .	24-26
Nugget Ice Machines. . . . .	16-17		

## NOTATIONS

Shipping weights are approximate.  
Modular ice machines are not stackable.

## TERMS

### TERMS

Terms are as Company may extend to purchaser.

Terms for Parts

C.O.D. (Deviation on authorization of Credit Department only.)

### PRICES

Prices are Ex-works Manitowoc, Wisconsin.  
All prices and specifications are subject to change without notice.

## DIMENSION DRAWINGS

Height includes legs set at 6" (15.2 cm).

Legs adjust from 6" – 7.5" (15.2 – 19.1 cm)

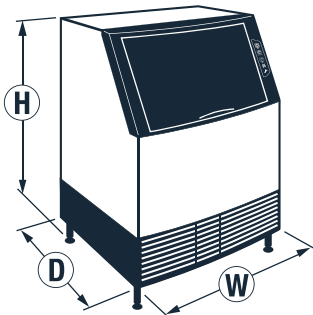

## COMMERCIAL WARRANTY

This is a limited warranty. For full terms, visit [manitowocice.com/Service/Warranty](http://manitowocice.com/Service/Warranty) or call 920-682-0161.

### WARRANTY – CUBE ICE MACHINE

- 5-year parts-and-labor coverage on Indigo NXT, S, U, Q0 and IB-model ice machine evaporators.
- 5-year parts and 3-year labor coverage on Indigo NXT, S, U, Q0 and IB-model ice machine compressor.
- 3-year parts-and-labor coverage on all dispensers, storage bins, and Indigo NXT, S, U, Q0 and IB-model ice cube machines.

### WARRANTY – UE SERIES ICE MACHINE

- 3-year parts-and-labor coverage on all components.

### WARRANTY – UCP AND USP SERIES ICE MACHINES

- 3-year parts-and-labor coverage on all components.

### WARRANTY – UFP/RFP, UNP/RNP ICE MACHINES

- 3-year parts.
- 3-year labor.
- Compressor parts for five (5) years and labor for three (3) years.

### WARRANTY – COUNTERTOP NUGGET DISPENSER ICE MACHINES (CNP201/202)

- 2-year parts-and-labor coverage on all components.
- Compressor parts for five (5) years and labor for two (2) years.

### WARRANTY – RELATED ACCESSORIES

If not stated, kits carry the same basic warranty as the machine they are used on.

## RESIDENTIAL WARRANTY

- 1-year parts-and-labor.

## ICE STYLES

<b>DICE CUBE:</b>	7/8" x 7/8" x 7/8" 2.22 x 2.22 x 2.22 cm 100% ice to water ratio.
<b>HALF DICE CUBE:</b>	3/8" x 1 1/8" x 7/8" 0.95 x 2.86 x 2.22 cm 100% ice to water ratio.
<b>REGULAR CUBE:</b>	1 1/8" x 1 1/8" x 7/8" 2.86 x 2.86 x 2.22 cm 100% ice to water ratio.
<b>GOURMET CUBE:</b>	1 3/8" x 1 3/8" 3.94 x 3.94 octagon shape cube. 100% ice to water ratio.
<b>NUGGET ICE:</b>	3/8" to 1/2" 0.76 x 0.76 x 1.27 cm pieces. 85% ice to water ratio.
<b>FLAKE ICE:</b>	Flake ice is smaller bits of ice. 73% ice to water ratio.
<b>SQUARE CUBE:</b>	1" square shaped ice. 100% ice to water ratio.
<b>LARGE SQUARE CUBE:</b>	40g, 1.5" x 1.5" x 1.5" square shaped ice. 100% ice to water ratio.

## ICE STORAGE CAPACITY

The calculation used to determine actual ice storage capacity varies among manufacturers, most use the AHRI standard. When the AHRI standard is not referenced, use cubic meters capacity for accurate comparison between manufacturer's models.

## READING MODEL NUMBERS

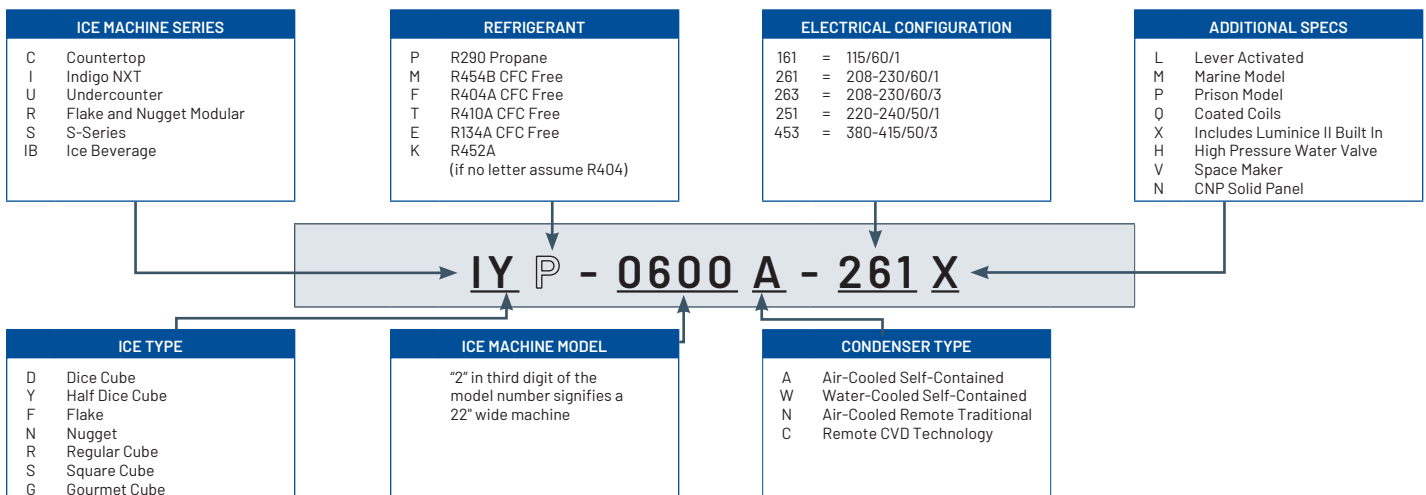

## UNDERCOUNTER CUBE

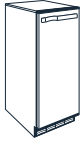

W 14.75" • D 22.75" • H 33.5"  
W 37.5 • D 57.8 H • 85.1 cm

53 lbs (24 kgs) daily at 70/50°F\*  
44 lbs (20 kgs) daily at 90/70°F\*



W 19.69" • D 22.34" • H 36"  
W 50.0 D • 56.7 H • 91.4 cm

**UDP0065:**  
62 lbs (28 kgs) daily at 70/50°F\*  
48 lbs (22 kgs) daily at 90/70°F\*  
**UDP0080:**  
110 lbs (50 kgs) daily at 70/50  
75 lbs (34 kgs) daily at 90/70



W 26" D 28.5" H 38.5"  
W 66 D 72.4 H 97.8 cm

**UP-140:**  
\*150 lbs (68 kgs) daily at 70/50°F  
\*114 lbs (52 kgs) daily at 90/70°F  
**UP-190:**  
\*200 lbs (91 kgs) daily at 70/50°F  
\*180 lbs (82 kgs) daily at 90/70°F



W 26" D 28.5" H 38.5"  
W 66 D 72.4 H 97.8 cm

\*250 lbs (114 kgs) daily at 70/50°F  
\*200 lbs (91 kgs) daily at 90/70°F

Model	Ice Type	Cooling	Electrical	Shipping Weight	Suggested List Price	Replaces Model
<b>UCP0050A-161</b>	Gourmet	Air	115v/60Hz/1	114 lbs (52 kgs)	<b>\$6,500</b>	<b>SMS050A002-161</b>

Ice storage capacity 25 lbs (11.3 kgs)  
Includes 6ft (1.8m) power cord with NEMA 5-15P plug.  
Includes AR-2800 water filter.  
Drain pump available as accessory (K00376).  
Not compatible with iAuCS®.  
**IMPORTANT NOTE:** Use only Metal Safe Cleaner 000000084 on this product. Other cleaners will damage the evaporator and will not be covered under warranty.

Model	Description	Shipping Weight	Suggested List Price
<b>K00376</b>	Drain pump for use when floor drain is not available	7 lbs (kgs)	<b>\$949</b>

Model	Ice Type	Cooling	Electrical	Shipping Weight	Suggested List Price	Replaces Model
<b>UDP0065A-161</b>	Dice	Air	115v/60Hz/1	109 lbs (49 kgs)	<b>\$5,332</b>	<b>UDE0065A-161B</b>
<b>UDP0080A-161</b>	Dice	Air	115v/60Hz/1	114 lbs (52 kgs)	<b>\$6,117</b>	<b>UDE0080A-161B</b>
<b>UDE0065A-251Z</b>	Dice	Air	230v/50/Hz/1	109 lbs (49 kgs)	<b>\$5,599</b>	<b>UDE0065A-251Z</b>
<b>UDP0080A-251Z</b>	Dice	Air	230v/50/Hz/1	114 lbs (52 kgs)	<b>\$6,423</b>	<b>UDP0080A-251Z</b>

Ice storage capacity 30 lbs (14 kgs)†. Storage capacity is AHRI certified, measured at 1.059 cu ft.  
Includes 6 ft (1.8m) power cord with NEMA 5-15P plug.  
Price list performance rating is 60hz data.  
Refer to individual 50hz spec sheets for 50hz performance rating.  
Not compatible with iAuCS or LuminIce II.

Model	Ice Type	Cooling	Electrical	Shipping Weight	Suggested List Price	Replaces Model
<b>URP0140A-161B★</b>	Regular	Air	115v/60Hz/1	153 lbs (69 kgs)	<b>\$6,592</b>	<b>URF0140A-161B</b>
<b>UDP0140A-161B★</b>	Dice	Air	115v/60Hz/1	153 lbs (69 kgs)	<b>\$6,392</b>	<b>UDF0140A-161B</b>
<b>UYP0140A-161B★</b>	Half Dice	Air	115v/60Hz/1	153 lbs (69 kgs)	<b>\$6,392</b>	<b>UYF0140A-161B</b>
<b>UYP0140A-161BX★</b>	Half Dice	Air	115v/60Hz/1	153 lbs (69 kgs)	<b>\$7,327</b>	<b>N/A</b>
<b>UDP0190A-161B★</b>	Dice	Air	115v/60Hz/1	153 lbs (69 kgs)	<b>\$6,725</b>	<b>UDF0190A-161B</b>
<b>UYP0190A-161B★</b>	Half Dice	Air	115v/60Hz/1	153 lbs (69 kgs)	<b>\$6,725</b>	<b>UYF0190A-161B</b>
<b>UYP0190A-161BX★</b>	Half Dice	Air	115v/60Hz/1	153 lbs (69 kgs)	<b>\$7,660</b>	<b>N/A</b>
<b>UDP0140A-251ZG</b>	Dice	Air	230v/50hz/1	153 lbs (69 kgs)	<b>\$6,711</b>	<b>UDF0140A-251Z</b>
<b>UYP0140A-251ZG</b>	Half Dice	Air	230v/50hz/1	153 lbs (69 kgs)	<b>\$6,711</b>	<b>UYF0140A-251Z</b>
<b>UDP0190A-251ZG</b>	Dice	Air	230v/50hz/1	153 lbs (69 kgs)	<b>\$7,062</b>	<b>UDF0190A-251Z</b>
<b>UYP0190A-251Z</b>	Half Dice	Air	230v/50hz/1	153 lbs (69 kgs)	<b>\$7,062</b>	<b>UYF0190A-251Z</b>

Cubic Volume of UP0140 is 3.9. Cubic Volume of UP0190 is 3.4. Storage capacity is AHRI certified.  
Application storage capacity† 90 lbs (40 kgs)  
Includes 6 ft (1.8m) power cord with NEMA 5-15P plug ("B" Plug).  
Price list performance rating is 60hz data. Refer to individual 50hz spec sheets for 50hz performance rating.  
Not compatible with iAuCS.  
X indicates LuminIce II factory installed. If factory installed LuminIce II not offered, use aftermarket kit found on page 24.

Model	Ice Type	Cooling	Electrical	Shipping Weight	Suggested List Price	Replaces Model
<b>UDP0240A-161B★</b>	Dice	Air	115v/60Hz/1	157 lbs (72kgs)	<b>\$7,745</b>	<b>UDF0240A-161B</b>
<b>UDP0240A-261ZG</b>	Dice	Air	208-230v/60hz/1	157 lbs (72kgs)	<b>\$7,820</b>	<b>UDF0240A-261Z</b>
<b>UDP0240W-161B</b>	Dice	Water	115v/60Hz/1	160 lbs (73 kgs)	<b>\$8,215</b>	<b>UDF0240W-161B</b>
<b>UYP0240A-161B★</b>	Half Dice	Air	115v/60Hz/1	159 lbs (72 kgs)	<b>\$7,745</b>	<b>UYF0240A-161B</b>
<b>UYP0240W-161B</b>	Half Dice	Water	115v/60Hz/1	159 lbs (72 kgs)	<b>\$8,215</b>	<b>UYF0240W-161B</b>
<b>UDP0240A-251ZG</b>	Dice	Air	230v/50hz/1	157 lbs (72kgs)	<b>\$7,896</b>	<b>UDP0240A-251Z</b>
<b>UYP0240A-251ZG</b>	Half Dice	Air	230v/50hz/1	159 lbs (72 kgs)	<b>\$7,896</b>	<b>UYP0240A-251Z</b>
<b>UYP0240W-251ZG</b>	Half Dice	Water	230v/50hz/1	159 lbs (72 kgs)	<b>\$8,287</b>	<b>UYF0240W-251Z</b>

Cubic Volume 3.4. Storage Capacity is AHRI certified.  
Application storage capacity† 90 lbs (40 kgs)  
Includes 6 ft (1.8 m) power cord with NEMA 5-15P plug ("B" Plug).  
Price list performance rating is 60hz data. Refer to individual 50hz spec sheets for 50hz performance rating.  
Not compatible with iAuCS. LuminIce II compatible as accessory.

\* Daily ice production based on half dice air-cooled condenser model at air temperature/water temperature.  
† Application storage capacity measured 90% of total volume in cubic feet. x 33 lbs / ft<sup>3</sup>

## UNDERCOUNTER CUBE (continued)

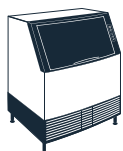

W 30" • D 28.5" • H 38.5"  
W 76.2 • D 72.4 • H 97.8 cm

330 lbs (150 kgs) daily at 70/50°F\*  
270 lbs (122 kgs) daily at 90/70°F\*

UP310	Model	Ice Type	Cooling	Electrical	Shipping Weight	Suggested List Price	Replaces Model
	URP0310A-161B★	Regular	Air	115v/60Hz/1	208 lbs (94 kgs)	\$9,627	URF0310A-161B
	UDP0310A-161B★	Dice	Air	115v/60Hz/1	208 lbs (94 kgs)	\$9,427	UDF0310A-161B
	UDP0310A-261ZG	Dice	Air	208-230v/60hz/1	208 lbs (94 kgs)	\$9,502	UDF0310A-261Z
	UDP0310W-161B	Dice	Water	115v/60Hz/1	211 lbs (96 kgs)	\$9,999	UDF0310W-161B
	UYPO310A-161B★	Half Dice	Air	115v/60Hz/1	209 lbs (95 kgs)	\$9,427	UYF0310A-161B
	UYPO310W-161B	Half Dice	Water	115v/60Hz/1	211 lbs (96 kgs)	\$9,999	UYF0310W-161B
	URP0310A-251ZG	Regular	Air	230v/50hz/1	208 lbs (94 kgs)	\$10,109	URF0310A-251Z
	UDP0310A-251ZG	Dice	Air	230v/50hz/1	208 lbs (94 kgs)	\$9,899	UDP0310A-251Z
	UYPO310A-251ZG	Half Dice	Air	230v/50hz/1	209 lbs (95 kgs)	\$9,899	UYF0310A-251Z

Application ice storage capacity† 119 lbs/54 kg. Cubic Volume 4.1. Storage Capacity is AHRI Certified.  
Includes 6"/1.8 m power cord with NEMA 5-15P plug ("B" Plug).  
Price list performance rating is 60hz data. Refer to individual 50hz spec sheets for 50hz performance rating.  
Not compatible with iAuCS. LuminIce® II compatible as accessory.

## SQUARE CUBE



W 19.68" • D 22.83" • H 37.5"  
100 lbs (45.5 kgs) at 70/50\*  
85 lbs (38.5 kgs) at 90/70\*

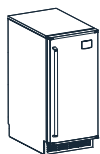

W 14.75" • D 22.75" • H 33.5"  
W 37.5 • D 57.8 • H 85.1 cm  
45 lbs (20 kgs) at 70/50\*  
35 lbs (15 kgs) at 90/70\*

USP0100A	Model	Ice Type	Cooling	Electrical	Shipping Weight	Suggested List Price	Replaces Model
	USP0100A-161	Square	Air	115v/60Hz/1	209 lbs (95 kgs)	\$6,812	N/A

Application storage capacity† 38 lbs/17.2 kgs. Measured volume is two (2) cubic feet. Storage Capacity is AHRI certified.  
Includes 6 ft (1.8m) power cord with NEMA 5-15 plug  
Refer to Install Use and Care manual for proper cleaning instructions.  
Not compatible with iAuCS or LuminIce II.

USE0050A	Model	Ice Type	Cooling	Electrical	Shipping Weight	Suggested List Price	Replaces Model
	USE0050A-161	Square	Air	115v/60Hz/1	121 lbs (54.4 kgs)	\$8,742	N/A

Ice storage capacity 25 lbs / 11.3 kg  
Includes 6 ft (1.8m) power cord with NEMA 5-15P plug  
Includes AR-2800 water filter  
Not compatible with iAuCS or LuminIce  
Use only metal safe cleaner 00000084

KIT	Model	Description	Shipping Weight	Suggested List Price
	K00516	Drain pump for use when floor drain is not available	7 lbs (9 kgs)	\$949
	K00517	Left door hinge kit	20 lbs (9 kgs)	\$1,016

★ ENERGY STAR® Qualified Model | Air filter standard on self-contained air-cooled ice cube machines.

\* Daily ice production based on half dice air-cooled condenser model at air temperature/water temperature.

† Application storage capacity measured 90% of total volume in cubic feet. x 33 lbs / ft<sup>3</sup>

MODULAR CUBE

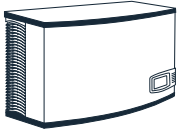

W 30" • D 24.5" • H 16.50"  
W 76.2 • D 62.2 • H 41.9 cm

325 lbs (148 kgs) daily at 70/50°F\*  
246 lbs (112 kgs) daily at 90/70°F\*

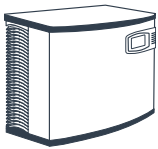

IP0320

W 55.9 • D 62.2 • H 54.6 cm  
145 kgs daily at 21/10°C  
108 kgs daily at 32/21°C

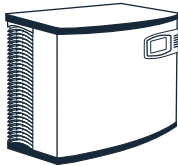

W 22" • D 24.5" • H 21.5"  
W 55.9 • D 62.2 • H 54.6 cm

478 lbs (210 kgs) daily at 70/50°F\*  
358 lbs (163 kgs) daily at 90/70°F\*

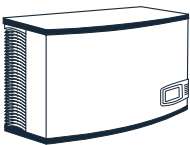

W 30" • D 24.5" • H 21.5"  
W 76.2 • D 62.2 • H 54.6 cm

478 lbs (217 kgs) daily at 70/50°F\*  
413 lbs (188 kgs) daily at 90/70°F\*



IP300 SERIES	Model	Ice Type	Cooling	Electrical	Shipping Weight	Suggested List Price	Replaces Model
	IDP0300A-161★	Dice	Air	115v/60Hz/1	142 lbs (64 kgs)	\$8,394	IDF0300A-161
	IDP0300A-161X	Dice	Air	115v/60Hz/1	147 lbs (67 kgs)	\$9,329	IDT0300A-161X
	IDT0300A-261★	Dice	Air	115v/60Hz/1	142 lbs (64 kgs)	\$8,469	IDF0300A-261
	IDT0300W-161	Dice	Water	115v/60Hz/1	139 lbs (63 kgs)	\$9,342	IDF0300W-161
	IYP0300A-161★	Half Dice	Air	115v/60Hz/1	147 lbs (67 kgs)	\$8,394	IYT0300A-161
	IYP0300A-161X	Half Dice	Air	115v/60Hz/1	152 lbs (69 kgs)	\$9,329	IYT0300A-161X
	IYP0300A-261★	Half Dice	Air	208-230/60Hz/1	147 lbs (67 kgs)	\$8,469	IYT0300A-261
	IYP0300W-161	Half Dice	Water	115v/60Hz/1	144 lbs (65 kgs)	\$9,342	IYT0300W-161
	IYT0300W-161X	Half Dice	Water	115v/60Hz/1	149 lbs (68 kgs)	\$10,277	IYF0300W-161X

If factory installed LuminIce II not offered, use aftermarket kit found on page 24.  
**RECOMMENDED BINS:** D400 or D570 (See page 19)  
 See pages 22-23 for required adapters, deflectors, and dispenser baffles.  
 Price list performance rating is 60hz data. Refer to individual 50hz spec sheets for 50hz performance rating.

IP0320A	Model	Ice Type	Cooling	Electrical	Shipping Weight	Suggested List Price	Replaces Model
	IDP0320A-251*	Dice	Air	230v/50/Hz/1	62 kgs (137 lbs)	\$10,503	N/A
	IYP0320A-251	Half Dice	Air	230v/50/Hz/1	64 kgs (138 lbs)	\$10,503	IYP0324A-251

R290 Propane Refrigerant  
 \*Daily ice production estimated based on 50 Hz, Half Dice air cooled condenser model at air temperature/ water temperature indicated.  
 For actual, reference spec sheet.

IP0420 SERIES	Model	Ice Type	Cooling	Electrical	Shipping Weight	Suggested List Price	Replaces Model
	IDP0420A-161★	Dice	Air	115v/60Hz/1	137 lbs (62 kgs)	\$9,260	IDT0420A-161
	IDP0420A-161X	Dice	Air	115v/60Hz/1	142 lbs (64 kgs)	\$10,195	IDT0420A-161X
	IDP0420A-261	Dice	Air	230v/60hz/1	137 lbs (62kgs)	\$9,335	IDT0420A-261
	IDP0420W-161	Dice	Water	115v/60Hz/1	131 lbs (59 kgs)	\$10,016	IDT0420W-161
	IYP0420A-161★	Half Dice	Air	115v/60Hz/1	136 lbs (62 kgs)	\$9,260	IYT0420A-161
	IYT0420A-161X	Half Dice	Air	115v/60Hz/1	141 lbs (64 kgs)	\$10,195	IY0324A-161X
	IYP0420W-161	Half Dice	Water	115v/60Hz/1	135 lbs (61 kgs)	\$10,016	IYT0420W-161
	IDP0420A-251	Dice	Air	230v/50hz/1	137 lbs (62 kgs)	\$9,514	IDT0420A-251
	IYP0420A-251	Half Dice	Air	230v/50Hz/1	136 lbs (62 kgs)	\$9,514	IYT0420A-251

If factory installed LuminIce II not offered, use aftermarket kit found on page 24.  
**Recommended Bins:** D320 or D420 (see page 19-20). See pages 22-23 for required adapters, deflectors, and dispenser baffles.  
 Price list performance rating is 60hz data. Refer to individual 50hz spec sheets for 50hz performance rating.

IP0450 SERIES	Model	Ice Type	Cooling	Electrical	Shipping Weight	Suggested List Price	Replaces Model
	IDP0450A-161★	Dice	Air	115v/60Hz/1	160 lbs (73 kgs)	\$9,071	IDT0450A-161
	IDP0450A-161X	Dice	Air	115v/60Hz/1	165 lbs /75 kg	\$10,006	IDT0450A-161X
	IDT0450W-161	Dice	Water	115v/60Hz/1	141 lbs (64 kgs)	\$9,809	ID0453W-161
	IDP0450W-161X	Dice	Water	115v/60Hz/1	146 lbs (66 kgs)	\$10,744	IDT0450W-161X
	IYP0450A-161	Half Dice	Air	115v/60Hz/1	170 lbs (77 kgs)	\$9,071	IYT0450A-161
	IYP0450A-161X	Half Dice	Air	115v/60Hz/1	175 lbs (79 kgs)	\$10,006	IYT0450A-161X
	IYP0450W-161	Half Dice	Water	115v/60Hz/1	155 lbs (70 kgs)	\$9,809	IYT0450W-161
	IYT0450W-161X	Half Dice	Water	115v/60Hz/1	160 lbs (73 kgs)	\$10,744	IY0455W-161X

If factory installed LuminIce II not offered, use aftermarket kit found on page 24.  
**Recommended Bins:** D400 or D570 (see page 19-20). See pages 22-23 for required adapters, deflectors, and dispenser baffles.  
 Price list performance rating is 60hz data. Refer to individual 50hz spec sheets for 50hz performance rating.

★ ENERGY STAR® Qualified Model | Air filter standard on self-contained air-cooled ice cube machines.  
 \* Daily ice production based on half dice air-cooled condenser model at air temperature/water temperature.  
 † Application storage capacity measured 90% of total volume in cubic feet. x 33 lbs / ft³

MODULAR CUBE (continued)

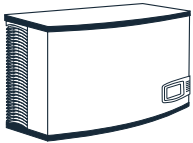

W 30" • D 24.5" • H 21.5"  
W 76.2 • D 62.2 • H 54.6 cm

516 lbs (235 kgs) daily at 70/50°F\*  
444 lbs (202 kgs) daily at 90/70°F\*



Model	Ice Type	Cooling	Electrical	Shipping Weight	Suggested List Price	Replaces Model
IRP0500A-161★	Regular	Air	115v/60Hz/1	162 lbs (73 kgs)	\$10,490	IRT0500A-161
IRT0500A-261★	Regular	Air	208-230v/60Hz/1	162 lbs (73 kgs)	\$10,565	IR0500A-261
IRP0500W-161	Regular	Water	115v/60Hz/1	158 lbs (72 kgs)	\$11,220	IR0501W-161
IDP0500A-161★	Dice	Air	115v/60Hz/1	157 lbs (72kgs)	\$10,240	IDT0500A-161
IDT0500A-161X	Dice	Air	115v/60Hz/1	162 lbs (73 kgs)	\$11,175	ID0502A-161X
IDP0500A-261★	Dice	Air	208-230v/60hz/1	157 lbs (72kgs)	\$10,315	ID0502A-261
IDP0500W-161	Dice	Water	115v/60Hz/1	163 lbs (74 kgs)	\$10,970	IDT0500W-161
IDF0500N-161A	Dice	Remote	115v/60Hz/1	164 lbs (74 kgs)	\$10,004	IDT0500N-161
IDF0500N-161AX	Dice	Remote	115v/60Hz/1	169 lbs (77 kgs)	\$10,939	IDT0500N-161X
IYP0500A-161★	Half Dice	Air	115v/60Hz/1	159 lbs (72 kgs)	\$10,240	IYT0500A-161
IYP0500A-161X★	Half Dice	Air	115v/60Hz/1	164 lbs (74 kgs)	\$11,175	IYT0500A-161X
IYP0500A-261★	Half Dice	Air	208-230v/60hz/1	159 lbs (72 kgs)	\$10,315	IYT0500A-261
IYP0500W-161	Half Dice	Water	115v/60Hz/1	161 lbs (73 kgs)	\$10,970	IYT0500W-161
IYF0500N-161A	Half Dice	Remote	115v/60Hz/1	161 lbs (73 kgs)	\$10,004	IYT0500N-161
IYF0500N-161AX	Half Dice	Remote	115v/60Hz/1	166 lbs (75 kgs)	\$10,939	IYT0500N-161X
IYP0500A-251G	Half Dice	Air	208-230v/50hz/1	155 lbs (70.5 kgs)	\$10,513	IYT0450A-251
IDP0500A-251G	Dice	Air	208-230v/50hz/1	153 lbs (69.5kgs)	\$10,513	IDT0500A-251

iP0500 / iF0500N SERIES

If factory installed LuminIce II not offered, use aftermarket kit found on page 24.  
**Recommended Bins:** D400 or D570 (see page 19-20). See pages 22-23 for required adapters, deflectors, and dispenser baffles.  
 Price list performance rating is 60hz data. Refer to individual 50hz spec sheets for 50hz performance rating.

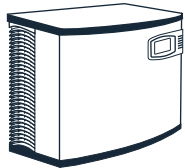

W 22" • D 24.5" • H 21.5"  
W 55.9 • D 62.2 • H 54.6 cm

537 lbs (244 kgs) daily at 70/50°F\*  
417 lbs (190 kgs) daily at 90/70°F\*



Model	Ice Type	Cooling	Electrical	Shipping Weight	Suggested List Price	Replaces Model
IRP0620A-161	Regular	Air	115v/60Hz/1	134 lbs (61 kgs)	\$10,141	IRT0620A-161
IDP0620A-161	Dice	Air	115v/60Hz/1	132 lbs (60kgs)	\$9,891	IDT0620A-161
IDP0620A-161X	Dice	Air	115v/60Hz/1	148 lbs (67 kgs)	\$10,826	IDT0620A-161X
IDP0620A-261	Dice	Air	208-230v/60hz/1	132 lbs (60kgs)	\$9,966	IDT0620A-261
IDP0620W-161	Dice	Water	115v/60Hz/1	140 lbs (63 kgs)	\$10,597	IDT0620W-161
IYP0620A-161	Half Dice	Air	115v/60Hz/1	131 lbs (59 kgs)	\$9,891	IYT0620A-161
IYP0620A-161X	Half Dice	Air	115v/60Hz/1	131 lbs (59 kgs)	\$10,826	IYT0620A-161X
IYP0620A-261	Half Dice	Air	208-230v/60hz/1	145 lbs (66 kgs)	\$9,966	IYT0620A-261
IYT0620W-161	Half Dice	Water	115v/60Hz/1	132 lbs (60 kgs)	\$10,597	IY0525W-161
IYP0620W-261	Half Dice	Water	208-230v/60hz/1	132 lbs (60 kgs)	\$10,672	IYT0620W-261
IRP0620A-251	Regular	Air	230v/50hz/1	134 lbs (62 kgs)	\$10,446	IRT0620A-251
IDT0620A-251	Dice	Air	230v/50hz/1	140 lbs (63 kgs)	\$10,157	ID0522A-251
IDP0620W-251	Dice	Water	230v/50hz/1	132 lbs (60 kgs)	\$10,660	IDT0620W-251
IYT0620A-251	Half Dice	Air	230v/50hz/1	145 lbs (66 kgs)	\$10,157	IY0524A-251

iP0620 SERIES

If factory installed LuminIce II not offered, use aftermarket kit found on page 24.  
**Recommended Bins:** D320 or D420 (see page 19-20).  
 See pages 22-23 for required adapters, deflectors, and dispenser baffles.  
 Price list performance rating is 60hz data. Refer to individual 50hz spec sheets for 50hz performance rating.

★ ENERGY STAR® Qualified Model | Air filter standard on self-contained air-cooled ice cube machines.  
 \* Daily ice production based on half dice air-cooled condenser model at air temperature/water temperature.  
 † Application storage capacity measured 90% of total volume in cubic feet. x 33 lbs / ft<sup>3</sup>

**MODULAR CUBE (continued)**

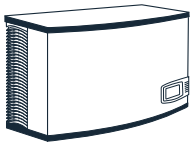

W 30" • D 24.5" • H 21.5"  
W 76.2 • D 62.2 H • 54.61cm

672 lbs (307 kgs) daily at 70/50  
554 lbs (252 kgs) daily at 90/70

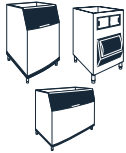

**IP0600 / IT0750 SERIES**

Model	Ice Type	Cooling	Electrical	Shipping Weight	Suggested List Price	Replaces Model
IDP0600A-161★	Dice	Air	115v/60Hz/1	161 lbs (73 kgs)	\$11,078	N/A
IDP0600W-161	Half Dice	Water	115v/60Hz/1	153 lbs (70kgs)	\$11,878	N/A
IYP0600A-161★	Half Dice	Air	115v/60Hz/1	155 lbs (70 kgs)	\$11,078	N/A
IYP0600A-161X★	Half Dice	Air	115v/60Hz/1	155 lbs (70 kgs)	\$12,013	N/A
IYP0600W-161	Half Dice	Water	115v/60Hz/1	153 lbs (70kgs)	\$11,878	N/A
IDP0600A-261★	Dice	Air	208-230v/60hz/1	194 lbs (88 kgs)	\$11,153	IDT0750A-261
IDP0600W-261	Dice	Water	208-230v/60hz/1	153 lbs (70 kgs)	\$11,953	IDT0750W-261
IDT0750N-261★	Dice	Remote	208-230v/60Hz/1	214 lbs (97 kgs)	\$10,852	IDF0600N-261A
IYP0600A-261★	Half Dice	Air	208-230v/60hz/1	208 lbs (94 kgs)	\$11,153	IYT0750A-261
IYP0600W-261	Half Dice	Water	208-230v/60hz/1	195 lbs (88 kgs)	\$11,953	IYT0750W-261
IYT0750N-261★	Half Dice	Remote	208-230v/60Hz/1	221 lbs (100 kgs)	\$10,852	IYF0600N-261A
IYT0750N-261X★	Half Dice	Remote	208-230v/60Hz/1	226 lbs (103 kgs)	\$11,787	IYF0600N-261AX
IYP0600A-251	Half Dice	Air	230v/50hz/1	155 lbs (70 kgs)	\$11,488	IYT0750A-251
IYP0600W-251	Half Dice	Water	230v/50hz/1	153 lbs (70 kgs)	\$12,062	IYT0750W-251
IYT0750N-251	Half Dice	Remote	230v/50hz/1;	221 lbs (100kgs)	\$11,082	IYF0600N-251A

If factory installed LuminIce II not offered, use aftermarket kit found on page 24.  
**Recommended Bins:** D570, D970 or F700 (see page 19-20).  
 See pages 22-23 for required adapters, deflectors, and dispenser baffles.  
 Use JCT1,200 remote condenser and RT( )R-410A tubing kit (see page 10).  
 Kit K00347 ice deflector must be ordered separately if used with: non-Manitowoc bins, Manitowoc F-Style bins.  
 Price list performance rating is 60hz data. Refer to individual 50hz spec sheets for 50hz performance rating.

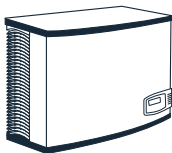

W 30" • D 24.5" • H 26.5"  
W 76.2 • D 62.2 • H 67.3 cm

775 lbs (352 kgs) daily at 70/50°F\*  
674 lbs (306 kgs) daily at 90/70°F\*



**IP0800 / IT0900 SERIES**

Mode	Ice Type	Cooling	Electrical	Shipping Weight	Suggested List Price	Replaces Model
IRP0800A-261★	Regular	Air	208-230v/60hz/1	213 lbs (97 kgs)	\$15,137	IRT0900A-261
IRP0800W-261	Regular	Water	208-230v/60hz/1	184 lbs (84 kgs)	\$16,245	IRT0900W-261
IDP0800A-261★	Dice	Air	208-230v/60hz/1	214 lbs (97 kgs)	\$14,837	IDT0900A-261★
IDP0800A-261X	Dice	Air	208-230v/60hz/1	219 lbs (99 kgs)	\$15,772	IDT0900A-261X
IDT0900W-261	Dice	Water	208-230v/60hz/1	212 lbs (96 kgs)	\$15,894	IDF0900W-261
IDT0900N-261★	Dice	Remote	208-230v/60Hz/1	221 lbs (100 kgs)	\$15,480	IDF0900N-261A
IYP0800A-261★	Half Dice	Air	208-230v/60hz/1	218 lbs (99 kgs)	\$14,837	IYT0900A-261
IYP0800A-261X	Half Dice	Air	208-230v/60hz/1	183 lbs (83 kgs)	\$15,772	IYT0900A-261X
IYP0800W-261	Half Dice	Water	208-230v/60hz/1	218 lbs (99 kgs)	\$15,894	IYT0900W-261
IYT0900N-261★	Half Dice	Remote	208-230v/60Hz/1	218 lbs (99 kgs)	\$15,480	IYF0900N-261A
IRP0800A-251	Regular	Air	230v/50hz/1	181 lbs (82 kgs)	\$15,878	IRT0900A-251
IRP0800W-251	Regular	Water	208-230v/50Hz/1	184 lbs (84 kgs)	\$16,672	IRT0900W-251
IDP0800A-251	Dice	Air	208-230v/50Hz/1	180 lbs (82 kgs)	\$15,578	IDT0900A-251
IYP0800A-251	Half Dice	Air	230v/50hz/1	183 lbs (83 kgs)	\$15,578	IYT0900A-251
IYT0900N-251	Half Dice	Remote	230v/50/Hz/1	218 lbs (99 kgs)	\$15,587	IYF0900N-251A

If factory installed LuminIce II not offered, use aftermarket kit found on page 24.  
**Recommended Bins:** D570, D970 or F700, FC1350 (see page 19-20).  
 See pages 22-23 for required adapters, deflectors, and dispenser baffles.  
 Use JCT1200 remote condenser and RT( )R-410A tubing kit (see page 10).  
 Kit K00347 ice deflector must be ordered separately if used with: non-Manitowoc bins, Manitowoc F-Style bins.  
 Price list performance rating is 60hz data. Refer to individual 50hz spec sheets for 50hz performance rating.

★ ENERGY STAR® Qualified Model | Air filter standard on self-contained air-cooled ice cube machines.  
 \* Daily ice production based on half dice air-cooled condenser model at air temperature/water temperature.

MODULAR CUBE (continued)

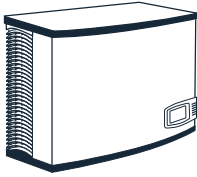

W 30" • D 24.5" • H 29.5 in  
W 76.2 • D 62.2 • H 74.9 cm

985 lbs (448 kgs) daily at 70/50°F\*  
883 lbs (401 kgs) daily at 90/70°F\*

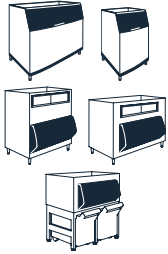

IP1000 / IT1200 SERIES

Model	Ice Type	Cooling	Electrical	Shipping Weight	Suggested List Price	Replaces Model
IDT1200A-261	Dice	Air	208-230v/60hz/1	232 lbs (105 kgs)	\$16,781	ID1106A-261
IDT1200W-261	Dice	Water	208-230v/60hz/1	228 lbs (103 kgs)	\$17,968	ID1106W-261
IDT1200N-261	Dice	Remote	208-230v/60hz/1	228 lbs (103 kgs)	\$17,209	IDT1200N-261
IYT1200A-261	Half Dice	Air	208-230v/60hz/1	241 lbs (109 kgs)	\$16,781	IY1106A-261
IYP1000A-261X	Half Dice	Air	208-230v/60hz/1	246 lbs (112 kgs)	\$17,716	IYT1200A-261X
IYP1000A-263	Half Dice	Air	208-230v/60hz/3	241 lbs (109 kgs)	\$17,081	IYT1200A-263
IYT1200W-261	Half Dice	Water	208-230v/60hz/1	238 lbs (108 kgs)	\$17,968	IY1106W-261
IYP1000W-263	Half Dice	Water	208-230v/60hz/3	199 lbs (90 kgs)	\$18,268	IYT1200W-263
IYT1200N-261	Half Dice	Remote	208-230v/60hz/1	236 lbs (107 kgs)	\$17,209	IYT1200N-261
IYT1200N-263	Half Dice	Remote	208-230v/60hz/3	236 lbs (107 kgs)	\$17,509	IY1196N3-263
IDP1000A-251	Dice	Air	230v/50hz/1	206 lbs (94 kgs)	\$17,621	IDT1200A-251
IDP1000 W-251	Dice	Water	230v/50hz/1	199 lbs (90 kgs)	\$18,491	IDT1200W-251
IYP1000A-251	Half Dice	Air	230v/50hz/1	200 lbs (91 kgs)	\$17,621	IYT1200A-251
IYP1000W-251	Half Dice	Water	230v/50hz/1	199 lbs (90 kgs)	\$18,488	IYT1200W-251
IYT1200N-251	Half Dice	Remote	230v/50hz/1	236 lbs (107 kgs)	\$17,814	IYT1200N-251

If factory installed LuminIce II not ordered, use aftermarket kit found on page 24.  
**Recommended Bins:** D970, D570, F1300, F1325, FC1350 (see page 19-20)  
 See pages 22-23 for required adapters, deflectors, and dispenser baffles.  
 Use JCT1200 remote condenser and RT( JR-410A tubing kit (see page 10).  
 Kit K00347 ice deflector must be ordered separately if used with: non-Manitowoc bins, Manitowoc F-Style bins.  
 Price list performance rating is 60hz data. Refer to individual 50hz spec sheets for 50hz performance rating.

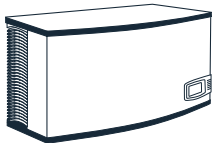

W 48" • D24.5" • H 29.5"  
W 121.9 • D 62.2 • H 74.9 cm

1660 lbs (753 kga) at 70/50°F\*  
1412 lbs (640 kgs) at 90/70°F\*

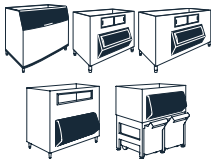

IT1500 SERIES

Model	Ice Type	Cooling	Electrical	Shipping Weight	Suggested List Price	Replaces Model
IDT1500A-261A	Dice	Air	208-230v/60hz/1	292 lbs (132 kgs)	\$20,395	IDT1500A-261
IDT1500A-263E	Dice	Air	208-230v/60hz/3	292 lbs (132 kgs)	\$20,745	IDT1500A-263
IDT1500W-261A	Dice	Water	208-230v/60hz/1	298 lbs (135 kgs)	\$21,633	IDT1500W-261
IDT1500W-263E	Dice	Water	208-230v/60hz/3	298 lbs (135 kgs)	\$21,983	IDT1500W-263
IDT1500N-261E★	Dice	Remote	208-230v/60hz/1	293 lbs (133 kgs)	\$20,140	IDT1500N-261A
IYT1500A-261A	Half Dice	Air	208-230v/60hz/1	292 lbs (132 kgs)	\$20,395	IYT1500A-261
IYT1500A-261AX	Half Dice	Air	208-230v/60hz/1	297 lbs (135 kgs)	\$21,330	IYT1500A-261X
IYT1500A-263E★	Half Dice	Air	208-230v/60hz/3	292 lbs (132 kgs)	\$20,745	IYT1500A-263
IYT1500W-261A	Half Dice	Water	208-230v/60hz/1	294 lbs (133 kgs)	\$21,228	IYT1500W-261
IYT1500N-261E★	Half Dice	Remote	208-230v/60hz/1	298 lbs (135 kgs)	\$20,140	IYT1500N-261A
IYT1500N-261EX	Half Dice	Remote	208-230v/60hz/1	303 lbs (137 kgs)	\$21,075	IYT1500N-261X
IYT1500N-263E★	Half Dice	Remote	208-230v/60hz/3	298 lbs (135 kgs)	\$20,490	IYT1500N-263
IDT1500A-251A	Dice	Air	230v/50hz/1	292 lbs (132 kgs)	\$21,063	IDT1500A-251
IDT1500W-251A	Dice	Water	230v/50hz/1	292 lbs (132 kgs)	\$22,103	IDT1500W-251
IYT1500A-251A	Half Dice	Air	230v/50hz/1	292 lbs (132 kgs)	\$21,063	IYT1500A-251
IYT1500W-251A	Half Dice	Water	230v/50hz/1	294 lbs (133 kgs)	\$22,103	IYT1500W-251
IYT1500N-251E	Half Dice	Remote	230v/50hz/1	298 lbs (135 kgs)	\$20,803	IYT1500N-251

If factory installed LuminIce II not offered, use aftermarket kit found on page 24.  
**Recommended Bins:** D970, F1300, F1325, F1650, FC1350 (See page 19-20s).  
 See pages 22-23 for required adapters and deflectors.  
 Use JCT1500 remote condenser and RL( JR-410A tubing kit (see page 10).  
 Kit K0034900 ice deflector must be ordered separately if used with: non-Manitowoc bins, Manitowoc F-Style bins.  
 Price list performance rating is 60hz data. Refer to individual 50hz spec sheets for 50hz performance rating.

★ ENERGY STAR® Qualified Model | Air filter standard on self-contained air-cooled ice cube machines.  
 \* Daily ice production based on half dice air-cooled condenser model at air temperature/water temperature.

MODULAR CUBE (continued)

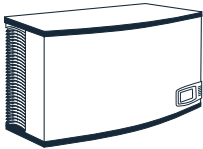

W 48" • D 24.5" • H 29.5"  
 W 121.9 • D 62.2 • H 74.9 cm  
 1965 lbs (891 kgs) at 70/50°F\*  
 1535 lbs (696 kgs) at 90/70°F\*

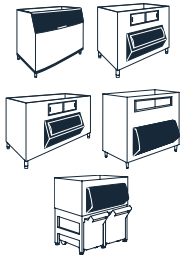

IT1900 SERIES

Model	Ice Type	Cooling	Electrical	Shipping Weight	Suggested List Price	Replaces Model
IRT1900A-261E	Regular	Air	208-230v/60hz/1	317 lbs (144 kgs)	\$24,278	IRT1900A-261
IRT1900A-263E	Regular	Air	208-230v/60hz/3	317 lbs (144 kgs)	\$24,628	IRT1900A-263
IRT1900N-261E	Regular	Remote	208-230v/60hz/1	324 lbs (147 kgs)	\$24,061	IRT1900N-261A
IRT1900N-263E	Regular	Remote	208-230v/60hz/3	324 lbs (147 kgs)	\$24,411	IRT1900N-263
IRT1900N-263EX	Regular	Remote	208-230v/60hz/3	324 lbs (147 kgs)	\$25,346	IRT1900N-263X
IDT1900A-263E	Dice	Air	208-230v/60hz/3	317 lbs (144 kgs)	\$24,328	IDT1900A-263
IDT1900W-261E	Dice	Water	208-230v/60hz/1	319 lbs (145 kgs)	\$25,674	IDT1900W-261A
IDT1900W-263E	Dice	Water	208-230v/60hz/3	319 lbs (145 kgs)	\$26,024	IDT1900W-263
IDT1900N-261E★	Dice	Remote	208-230v/60hz/1	324 lbs (147 kgs)	\$23,761	IDT1900N-261A
IDT1900N-263E★	Dice	Remote	208-230v/60hz/3	324 lbs (147 kgs)	\$24,111	IDT1900N-263
IYT1900A-261E	Half Dice	Air	208-230v/60hz/1	321 lbs (146 kgs)	\$23,978	IYT1900A-261
IYT1900A-263E	Half Dice	Air	208-230v/60hz/3	321 lbs (146 kgs)	\$24,328	IYT1900A-263
IYT1900W-261E	Half Dice	Water	208-230v/60hz/1	322 lbs (146 kgs)	\$25,674	IYT1900W-261A
IYT1900W-263E	Half Dice	Water	208-230v/60hz/3	322 lbs (146 kgs)	\$26,024	IYT1900W-263
IYT1900N-261E★	Half Dice	Remote	208-230v/60hz/1	330 lbs (150 kgs)	\$23,761	IYT1900N-261A
IYT1900N-261EX	Half Dice	Remote	208-230v/60hz/1	335 lbs (152 kgs)	\$24,696	IYT1900N-261X
IYT1900N-263E★	Half Dice	Remote	208-230v/60hz/3	330 lbs (150 kgs)	\$24,111	IYT1900N-263
IYT1900N-263EX	Half Dice	Remote	208-230v/60hz/3	335 lbs (152 kgs)	\$25,046	IYT1900N-263X
IRT1900A-251E	Regular	Air	230v/50hz/1	317 lbs (144 kgs)	\$25,305	IRT1900A-251
IDT1900A-251E	Dice	Air	230v/50hz/1	317 lbs (144 kgs)	\$24,947	IDT1900A-251
IDT1900N-251E	Dice	Remote	230v/50hz/1	324 lbs (147 kgs)	\$24,723	IDT1900N-251
IYT1900A-251E	Half Dice	Air	230v/50hz/1	324 lbs (146 kgs)	\$24,947	IYT1900A-251

If factory installed LuminIce II not offered, use aftermarket kit found on page 24.  
**Recommended Bins:** D970, F1300, F1325, F1650, FC1350 (See page 20).  
 See pages 22-23 for required adapters and deflectors.  
 †Use JCT1500 remote condenser and RL( )JR-410A tubing kit (see page 10).  
 Kit K0034900 ice deflector must be ordered separately if used with: non-Manitowoc bins, Manitowoc F-Style bins.  
 Price list performance rating is 60hz data. Refer to individual 50hz spec sheets for 50hz performance rating.

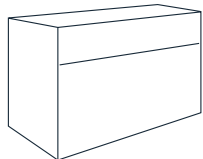

W 48" • D 31 in H 36"  
 W 121.9 • D 78.7 • H 91.4 cm  
 3200 lbs (1451 kgs) daily  
 at 70/50°F\*  
 2584 lbs (1172 kgs) daily at  
 90/70°F\*

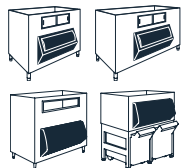

S-3000 SERIES

Model	Ice Type	Cooling	Electrical	Shipping Weight	Suggested List Price	Replaces Model
SDT3000W-263H	Dice	Water	208-230v/60hz/3/1	501 lbs (227 kgs)	\$43,260	SD3303W3-263HP
SYT3000W-263H	Half Dice	Water	208-230v/60hz/3	516 lbs (234 kgs)	\$43,260	SY3305W3-263HP

**Recommended Bins:** F1300, F1325, F1650, FC1350 (See page 20).  
 See pages 22-23 for required adapters and deflectors.  
 Not for use with iAuCS cleaning system or LuminIce II.  
 K00391 and K00396 Needed for the F1300. Requires adapter that does not come with the bin.  
 K604800 with the F1325 and F1650 and the K614800 for the FC1350.  
 H = High pressure valve regulates from 20 psi to 350 psi or 137.9 kPa to 2413.2 kPa.

★ ENERGY STAR® Qualified Model | Air filter standard on self-contained air-cooled ice cube machines.  
 \* Daily ice production based on half dice air-cooled condenser model at air temperature/water temperature.

# REMOTE

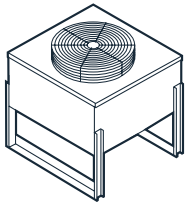

## STANDARD REMOTE AIR-COOLED CONDENSER

Model	For Use with Remote Ice Machine	Electrical	Shipping Weight	Suggested List Price	Replaces Model
JCF0500-161	iT0500N	115v/60hz/1	64 lbs (29 kgs)	\$2,897	JCT0500-161
JCF0500-161Q	iT0500N	115v/60hz/1	65 lbs (29 kgs)	\$3,197	JCT0500-161Q
JCT1200-261	iT0750N, iT0900N and iT1200N	208-230v/60hz/1	78 lbs (35 kgs)	\$3,407	JC0995-261
JCT1200-261Q	iT0750N, iT0900N and iT1200N	208-230v/60hz/1	79 lbs (36 kgs)	\$3,707	N/A
JCT1500-261	iT1500N and iT1900N	208-230v/60hz/1	80 lbs (36 kgs)	\$3,781	JC1395-261
JCT1500-261Q	iT1500N and iT1900N	208-230v/60hz/1	81 lbs (37 kgs)	\$4,081	JC1395-261Q
JCT1200-251	iT0750N, iT0900N and iT1200N	230v/50hz/1	78 lbs (35 kgs)	\$3,665	JC0995-251
JCT1500-251	iT1500N and iT1900N	230v/50hz/1	80 lbs (36 kgs)	\$4,122	JC1395-251

**NOTE:** Models with Q suffix are available with coated coils that provide extra corrosion protection in salt spray environments. Coated Coil models require longer lead time, please contact the factory.



## STANDARD REMOTE TUBING KITS & ACCESSORIES

Kit	For Use with Series	Tubing Length	Shipping Weight	Suggested List Price
RT20R404	iF0500, iF600 and iF900 Precharged with quick connects	20ft (6.1m)	10 lbs (5 kgs)	\$683
RT35R404	iF0500, iF600 and iF900 Precharged with quick connects	35ft (10.7m)	15 lbs (7 kgs)	\$840
RT50R404	iF0500, iF600 and iF900 Precharged with quick connects	50ft (15.2m)	22 lbs (10 kgs)	\$1,011
RT20R410A	iT0750N, iT0900N and iT1200 Precharged with quick connects	20ft (6.1m)	10 lbs (5 kgs)	\$703
RT35R410A	iT0750N, iT0900N and iT1200 Precharged with quick connects	35ft (10.7m)	15 lbs (7 kgs)	\$867
RT50R410A	iT0750N, iT0900N and iT1200 Precharged with quick connects	50ft (15.2m)	22 lbs (10 kgs)	\$1,041
RL20R410A	iT1500 and iT1900 Precharged with quick connects	20ft (6.1m)	10 lbs (5 kgs)	\$703
RL35R410A	iT1500 and iT1900 Precharged with quick connects	35ft (10.7m)	15 lbs (7 kgs)	\$867
RL50R410A	iT1500 and iT1900 Precharged with quick connects	50ft (15.2m)	22 lbs (10 kgs)	\$1,041

### Accessory

K00129	Remote Coupling Kit needed for non-Manitowoc Tubing		2 lbs (1 kgs)	\$238
--------	---	--	---------------	-------

**NOTE:** Manitowoc remote systems are only approved and warranted as a complete new package. Replacing an ice machine with an Indigo NXT, RNF or RNS model requires a NEW condenser and line set. Use of a new multi-circuited condenser is approved when sized and installed as outlined in Manitowoc Product Information. Rack system applications are not approved.

### Top Air Discharge Kits

K00379	Indigo NXT iT0450, iT0500, iF0600, iT0750		18 lbs (9 kgs)	\$770
K00438	Indigo NXT iT0420 and iT0620 models		17 lbs (8 kgs)	\$770
K00439	Indigo NXT iF0900 and iT0900		17 lbs (8 kgs)	\$770
K00449	Indigo NXT iT1200		18 lbs (9 kgs)	\$770
K00481B	Indigo NXT iT1500 and iT1900 models		29 lbs (13 kgs)	\$770

**NOTE:** Top air discharge kits are used when there is not sufficient clearance on the sides of an air cooled machine. These kits change the side panels and top panel so the air intake is from the back of the machine and the exhaust is re-routed out of the top of the machine rather than the sides.

QUIETQUBE ICE MACHINES

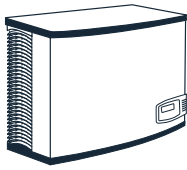

**IF0600C**  
W 30" • D 24.5" • H 21.5"  
W 76.2 • D 62.2 • H 54.6 cm  
**IF0900C**  
W 30" • D 24.5" • H 26.5"  
W 76.2 • D 62.2 • H 67.3 cm  
**IT1200C**  
W 30" • D 24.5" • H 29.5"  
W 76.2 • D 62.2 • H 74.9 cm

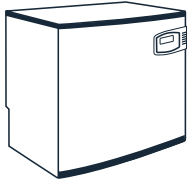

**IF1400C**  
W 30" • D 24.5" • H 25"  
W 76.2 • D 62.2 • H 63.5 cm  
**IT1830C/IF2100C**  
W 30" • D 24.5" • H 29.5"  
W 76.2 • D 62.2 • H 74.9 cm

K00526 is required when installing these ice machines on top of a Cornelius ProGate IDC255 Dispenser.

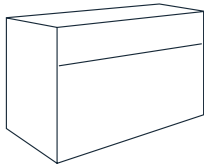

**SF3000C**  
W 48" • D 31" • H 36"  
W 121.9 • D 78.7 • H 91.4 cm

ICE / BEV ICE MACHINES

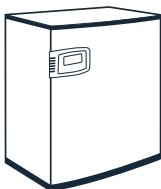

**IBF0620**  
W 22" • D 14" • H 24"  
W 55.9 • D 35.6 • H 61.0 cm  
**IBF0820**  
W 22" • D 14" • H 26.5"  
W 55.9 • D 35.6 • H 67.3 cm  
**IBT1020C**  
W 22" • D 14" • H 30.5"  
W 55.9 • D 35.6 • H 77.5 cm

QUIETQUBE AND ICE BEVERAGE MACHINES

Model	Ice Type	Cooling	Electrical	Shipping Weight	Suggested List Price	Replaces Model
IDT1200C-161	Dice	Remote	115v/60Hz/1	171 lbs (78 kgs)	\$15,552	ID1176C-161
IDF1400C-161	Dice	Remote	115v/60Hz/1	174 lbs (79 kgs)	\$17,527	IDT1430C-161
IDF1800C-161	Dice	Remote	115v/60Hz/1	210 lbs (95 kgs)	\$22,185	ID1872C-161
IDT1830C-161★	Dice	Remote	115v/60Hz/1	210 lbs (95 kgs)	\$22,185	IDF1800C-161
IDF2100C-161	Dice	Remote	115v/60Hz/1	210 lbs (95 kgs)	\$25,728	ID2176C-161
IYF0600C-161★	Half Dice	Remote	115v/60Hz/1	146 lbs (66 kgs)	\$11,296	IY0686C-161
IYF0900C-161★	Half Dice	Remote	115v/60Hz/1	161 lbs (73 kgs)	\$14,294	IY0976C-161
IYF0900C-161X	Half Dice	Remote	115v/60Hz/1	166 lbs (75 kgs)	\$15,229	IY0976C-161X
IYT1200C-161	Half Dice	Remote	115v/60Hz/1	174 lbs (79 kgs)	\$15,552	IY1176C-161
IYF1400C-161	Half Dice	Remote	115v/60Hz/1	179 lbs (81 kgs)	\$17,527	IYT1430C-161
IYF1400C-161X	Half Dice	Remote	115v/60Hz/1	184 lbs / 83 kg	\$18,462	IYT1430C-161X
IYF1800C-161	Half Dice	Remote	115v/60Hz/1	210 lbs (95 kgs)	\$22,185	IY1874C-161
IYF1800C-161 X	Half Dice	Remote	115v/60Hz/1	215 lbs (98 kgs)	\$23,120	IY1874C-161X
IYT1830C-161★	Half Dice	Remote	115v/60Hz/1	210 lbs (95 kgs)	\$22,185	IYF1800C-161
IYT1830C-161X★	Half Dice	Remote	115v/60Hz/1	215 lbs (98 kgs)	\$23,120	IYF1800C-161X
IYF2100C-161	Half Dice	Remote	115v/60Hz/1	210 lbs (95 kgs)	\$25,728	IY2176C-161
IYF2100C-161X	Half Dice	Remote	115v/60Hz/1	210 lbs (95 kgs)	\$26,663	IY2176-161X
SYF3000C-161	Half Dice	Remote	115v/60Hz/1	423 lbs (192 kgs)	\$38,058	SY3074C-161
IBF0620C-161	Half Dice	Remote	115v/60Hz/1	122 lbs (55 kgs)	\$12,824	IB0696YC-161
IBF0820C-161★	Half Dice	Remote	115v/60Hz/1	130 lbs (59 kgs)	\$15,298	IB0894YC-161
IBT1020C-161	Half Dice	Remote	115v/60Hz/1	148 lbs (67 kgs)	\$16,640	IB1094YC-161
IYF0600C-251	Half Dice	Remote	230v/50hz/1	146 lbs (66 kgs)	\$11,810	IY0686C-251
IYF1800C-251	Half Dice	Remote	230v/50hz/1	210 lbs (95 kgs)	\$22,885	IY1874C-251
IBT1020C-251	Half Dice	Remote	230v/50hz/1	148 lbs (67 kgs)	\$17,474	IBF0820C-251

If factory installed LuminIce II not offered, use aftermarket kit found on page 24.  
Price list performance rating is 60hz data. Refer to individual 50hz spec sheets for 50hz performance rating.

QUIETQUBE AND ICE BEVERAGE MACHINES

Daily Ice Production

MODEL	70/50°F	90/70°F	MODEL	70/50°F	90/70°F
IDT1200C	1,130 lbs (513 kgs)	930 lbs / 422 kg	IYF1400C	1,425 lbs (646 kgs)	1,230 lbs / 558 kg
IDF1400C	1,350 lbs (612 kgs)	1,120 lbs / 508 kg	IYT1830C	1,874 lbs (850 kgs)	1,560 lbs / 708 kg
IDT1830C	1,771 lbs (803 kgs)	1,500 lbs / 680 kg	IYF2100C	1,800 lbs (816 kgs)	1,600 lbs / 726 kg
IDF2100C	1,800 lbs (816 kgs)	1,575 lbs / 714 kg	SYF3000C	2,910 lbs (1,320 kgs)	2,400 lbs / 1,089 kg
IYF0600C	600 lbs (272 kgs)	530 lbs / 240 kg	IBF0620C	675 lbs (306 kgs)	564 lbs / 256 kg
IYF0900C	816 lbs (370 kgs)	675 lbs (306 kgs)	IBF0820C	825 lbs (374 kgs)	728 lbs / 330 kg
IYT1200C	1,155 lbs (525 kgs)	955 lbs / 433 kg	IBT1020C	1,206 lbs (547 kgs)	1,030 lbs / 467 kg

Ice deflectors required for single machines on F-Style bins.  
Two machines side by side require unique deflectors and adapters. (See page 22 for reference.)

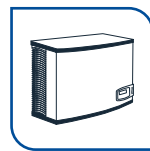

ICE MAKER

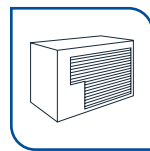

CONDENSING UNIT



TUBING



QuietQube®  
or  
Ice/Beverage  
Ice Making  
Components¹

**NOTE:** Manitowoc remote systems are only approved and warranted as a complete new package. Replacing an ice machine with an Indigo remote model requires a NEW condenser and line set. Only Manitowoc CVD condensing units are approved with QQ and IB Series machines.

¹Appropriate adapter is required with ice dispensers or storage bin. For Quiet Qube machines other than IB machines, an optional K00477 bin dispenser thermostat kit may be required for high humidity locations to reduce equipment sweating. IB ice machines come equipped from the factory with a built in bin dispenser thermostat.

★ ENERGY STAR® Qualified Model | Air filter standard on self-contained air-cooled ice cube machines.  
\* Daily ice production based on half dice air-cooled condenser model at air temperature/water temperature.

## CONDENSING UNITS

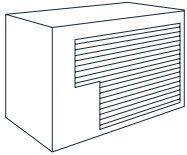

CVDF0600, CVDF0900,  
CVDT1200, CVDF1400,  
CVDF1800, RCUF1000,  
RCUF1200, RCUF2200  
W 34" • D 24.13" • H 25.75"  
W 86.4 • D 61.3 • H 65.4cm

### RJC1275

W 45.5" • D 16.5" • H 31"  
W 115.6 • D 42 • H 78.5 cm

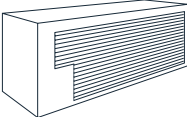

CVDF2100/CVDF3000  
W 53" • D 26" • H 25.75"  
W 134.6 • D 66 • H 65.4 cm

### RJC2375

W 51.4 • D 18.5" • H 45.7"  
W 130.6 • D 47 • H 116 cm

## CONDENSING UNITS

Model	Cooling	Use With	Electrical	Shipping Weight	Suggested List Price	Replaces Model
CVDF0600-261A	Air	IF0600C, IBF0620C	208-230v/60hz/1	178 lbs (81 kgs)	\$4,839	CVDF0600-261
CVDF0600-263A	Air	IF0600C, IBF0620C	208-230v/60hz/3	178 lbs (81 kgs)	\$5,139	CDF0600-263
CVDF0900-261A	Air	IF0900C, IBF0820C	208-230v/60hz/1	183 lbs (83 kgs)	\$5,479	CVDF0900-261
CVDF0900-263A	Air	IF0900C, IBF0820C	208-230v/60hz/3	183 lbs (83 kgs)	\$5,779	CVDF0900-263
CVDT1200-261	Air	IT1200C, IBT1020C	208-230v/60hz/1	208 lbs (94 kgs)	\$5,937	CVDT1200-261
CVDT1200-263	Air	IT1200C, IBT1020C	208-230v/60hz/3	208 lbs (94 kgs)	\$6,237	CVDT1200-261
CVDT1200-263Q	Air	IT1200C, IBT1020C	208-230v/60hz/3	208 lbs (94 kgs)	\$6,537	CVDT1200-263Q
CVDF1400-261A	Air	IF1400C	208-230v/60hz/1	190 lbs (86 kgs)	\$6,666	CVDT1400-261
CVDF1400-261AQ	Air	IF1400C	208-230v/60hz/1	190 lbs (86 kgs)	\$6,966	CVDT1400-261Q
CVDF1400-263A	Air	IF1400C	208-230v/60hz/3	190 lbs (86 kgs)	\$6,966	CVDT1400-263
CVDF1800-261A	Air	IF1800C	208-230v/60hz/1	195 lbs (88 kgs)	\$7,643	N/A
CVDT1800-261	Air	IT1830C	208-230v/60hz/1	195 lbs (88 kgs)	\$7,643	CVDF1800-261A
CVDT1800-263	Air	IT1830C	208-230v/60hz/3	195 lbs (88 kgs)	\$7,993	CVDF1800-263A
CVDT1800-261Q	Air	IT1830C	208-230v/60hz/1	195 lbs (88 kgs)	\$7,943	CVDF1800-261
CVDT1800-263Q	Air	IT1830C	208-230v/60hz/3	195 lbs (88 kgs)	\$8,293	CVDF1800-263Q
CVDF2100-261	Air	IF2100C	208-230v/60hz/1	266 lbs (121 kgs)	\$8,493	ICVD2096-261
CVDF2100-263	Air	IF2100C	208-230v/60hz/3	266 lbs (121 kgs)	\$8,843	ICVD2096-263
CVDF3000-263	Air	sF3000C	208-230v/60hz/3	268 lbs (122 kgs)	\$12,828	ICVD30853-263
RCUF1200-261	Air	RFF1220C	208-230v/60hz/1	201 lbs (91 kgs)	\$5,421	RCUF1200-261
RCUF1000-261A	Air	RNF1020C	208-230v/60hz/1	201 lbs (91 kgs)	\$5,316	RCUF1000-261
RCUF2200-263	Air	RFF2200C, RNF2000C	208-230v/60hz/3	249 lbs (113 kgs)	\$6,724	RCU23753-263
CVDF0600-251A	Air	IF0600C	230v/50hz/1	178 lbs (81 kgs)	\$4,955	CVDF0600-251
CVDT1200-251	Air	IBT1200C	230v/50hz/1	208 lbs (94 kgs)	\$6,253	N/A
CVDF1800-251A	Air	IF1800C	230v/50hz/1	195 lbs (88 kgs)	\$7,976	ICVD1895-251
RJC1275-453	Air	RFS1278C	380-415/50hz/3	315 lbs (143 kgs)	\$10,289	N/A
RJC2375-453	Air	RFS2378C	380-415/50hz/3	315 lbs (143 kgs)	\$14,474	N/A

NOTE: Models with "Q" suffix are available with coated coils that provide extra corrosion protection in salt spray environments

## QUIETQUBE® • IB REMOTE TUBING KITS • ACCESSORIES

KIT	Indigo NXT, Flake Nugget Remote Tubing kits	Shipping Weight	Suggested List Price
RC31	30 ft (9.1m) tubing length for CVD0600, CDV0900, CVD1200, CVDT1400, RCUF and RJC condensing units. Not Precharged	17 lbs (8 kgs)	\$681
RC51	50 ft (15.2m) tubing length for CVD0600, CVD0900, CVD1200, CVDT1400, RCUF and RJC condensing units. Not Precharged	27 lbs (12 kgs)	\$1,149
RC30	30 ft (9.1m) tubing length for CVDF1400, and CVDT1800. Not Precharged	20 lbs (9 kgs)	\$781
RC50	50 ft (15.2m) tubing length for CVDF1400, and CVDT1800. Not Precharged	31 lbs (14 kgs)	\$1,236
RC33	30 ft (9.1m) tubing length for CVD2100. Not Precharged	25 lbs (11 kgs)	\$1,138
RC53	50 ft (15.2m) tubing length for the CVD2100. Not Precharged	39 lbs (18 kgs)	\$1,869
K00166	S-Trap kit for CVDF1400, 1800, 2100 and CVD3000 condensing units with line set rise over 20 ft / 6.1 m		\$126
K00172	S-trap kit for Indigo NXT series CVD0600, 0900, 12000 and CVDT1400 condensing units with line set rise over 20 ft / 6.1 m		\$126
<b>SF3000C Tubing Kits</b>			
RC34	30 ft (9.1m) Tubing length for CVD3000	47 lbs (21 kgs)	\$1,442
RC54	50 ft (15.2 m) Tubing length for CVD3000	73 lbs (33 kgs)	\$2,333
<b>IB ADAPTER FOR CORNELIUS DISPENSER: Ordered and shipped from Manitowoc Ice</b>			
K00340	For 22 in (55.9 cm) wide Enduro 150 for McDonald's ABS unit	27 lbs (12 kgs)	\$1,676
K00342	30 in (76.2 cm) Enduro 200 (250)	31 lbs (14 kgs)	\$2,081
K00343	44 in (111.8 cm) Enduro 300	47 lbs (21 kgs)	\$2,484
<b>IB Accessory</b>			
K00436	IBT1020C Back Enclosure Kit (for IB1094YC and IBT1020C only) Hides electrical and water lines for pleasing appearance.	12 lbs (5 kgs)	\$412

## SPECIALTY MODELS

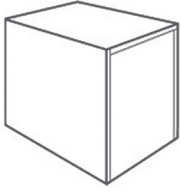

W 34" • D 24.13" • H 25.75"  
W 86.4 • D 61.3 • H 65.4cm

RJC1275

W 45.5" • D 16.5" • H 31"  
W 115.6 • D 42 H • 78.5 cm

PRISON	Model	Ice Type	Cooling	Electrical	Shipping Weight	Suggested List Price	Replaces Model
	IDP0450A-161P	Dice	Air	115v/60Hz/1	152 lbs (69 kgs)	\$10,246	IDT0450A-161P
	IDP0600A-161P	Dice	Air	208-230v/60hz/1	161 lbs (73 kgs)	\$12,253	IDT0750A-261P
	IDP1000A-261P	Dice	Air	208-230v/60hz/1	202 lbs (92 kgs)	\$17,956	IDT100A-261P
	IDT1500A-261AP	Dice	Air	208-230v/60hz/1	292 lbs (132 kgs)	\$21,570	IDT1500A-261P

**NOTE:** For dimensions and performance see base model  
Prison models require more lead time than normal, please contact the factory.  
LuminIce II is available as an after-market kit. Please see page 24.

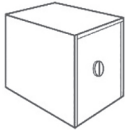
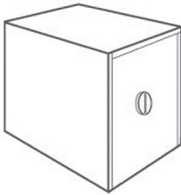

MARINE	Model	Ice Type	Cooling	Electrical	Shipping Weight	Suggested List Price	Replaces Model	
	IDT0750W-261M	Dice	Water	208-230v/60hz/1	194 lbs (88 kgs)	\$17,208	IDF0600W-261M	
	IDT0900W-261M	Dice	Water	208-230v/60hz/1	212 lbs (96 kgs)	\$22,219	IDF0900W-261M	
	IDT1900W-261EM	Dice	Water	208-230v/60hz/1	334 lbs (151 kgs)	\$30,494	IDT1900W-261AM	
	IYT0900W-261M	Half Dice	Water	208-230v/60hz/1	218 lbs (99 kgs)	\$22,219	IYF0900W-261M	
	IYT1900W-261EM	Half Dice	Water	208-230v/60hz/1	337 lbs (153 kgs)	\$30,494	IYT1900W-261AM	
	IYT1900W-263EM	Half Dice	Water	208-230v/60hz/3	337 lbs (153 kgs)	\$30,844	IYT1900W-263M	
	<b>NOTE:</b> For dimensions and performance see base model Marine models require more lead time than normal, please check with the factory.							
	IDT0900W-261V	Dice	Water	208-230v/60hz/1	212 lbs (96 kgs)	\$23,218	IDF0900W-261V	
	IYT0900W-261V	Half Dice	Water	208-230v/60hz/1	218 lbs (99 kgs)	\$23,218	IYF0900W-261V	
IDT1900W-261EV	Dice	Water	208-230v/60hz/1	334 lbs / 151kg	\$31,410	IDT1900W-261V		
IYT1900W-261EV	Half Dice	Water	208-230v/60hz/1	337 lbs / 153kg	\$31,410	IYT1900W-261V		

**NOTE:** For dimensions and performance see base model  
Marine models require more lead time than normal, please check with the factory.

★ ENERGY STAR® Qualified Model | Air filter standard on self-contained air-cooled ice cube machines.

\* Daily ice production based on half dice air-cooled condenser model at air temperature/water temperature.



## UNDERCOUNTER FLAKE



W 19.7" • D 26" • H 37.5"  
W 50.0 • D 66.0 • H 95.3 cm

272 lbs (123 kgs) daily at 70/50°F\*  
201 lbs (91 kgs) daily at 90/70°F\*

Model	Ice Type	Cooling	Electrical	Shipping Weight	Suggested List Price	Replaces Model
<b>UFP0200A-161★</b>	Flake	Air	115v/60hz/1	168 lbs (76 kgs)	<b>\$11,605</b>	UFF0200A-161
<b>UFK0200AZ-251</b>	Flake	Air	230v/50hz/1	168 lbs (76 kgs)	<b>\$11,788</b>	RF0266AZ-251

Application Storage Capacity<sup>†</sup>: 50 lbs / 23 kg. Cubic volume 1.7. Storage capacity is AHRI certified.  
Includes 6 ft / 1.8 m power cord with NEMA 5-15P plug.  
Use cleaner (000000084) only with this model.  
Not compatible with iAuCS® or LuminIce II.  
Price list performance rating is 60hz data.  
50 Hz Electric Connection: Add Z for Bare Lead cord.



W 29" • D 27" • H 39.5"  
W 73.8 • D 69.0 • H 100.4 cm

400 lbs (181 kgs) daily at 70/50°F\*  
321 lbs (145 kgs) daily at 90/70°F\*

Model	Ice Type	Cooling	Electrical	Shipping Weight	Suggested List Price	Replaces Model
<b>UFP0350A-161★</b>	Flake	Air	115v/60hz/1	224 lbs (102 kgs)	<b>\$12,071</b>	UFF0350A-161
<b>UFK0350AZ-251</b>	Flake	Air	230v/50hz/1	224 lbs (102 kgs)	<b>\$12,258</b>	RF0385AZ-251

Application Storage Capacity<sup>†</sup>: 60 lbs/27 kg. Measured cubic volume 2.04 Storage Capacity is AHRI certified  
Includes 6 ft / 1.8 m power cord with NEMA 5-15P plug.  
Use cleaner (000000084) only with this model.  
Not compatible with iAuCS or LuminIce II.  
Price list performance rating is 60hz data.  
50 Hz Electric Connection: Add Z for Bare Lead cord.

## MODULAR FLAKE

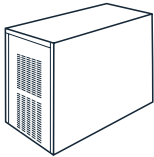

W 22" • D 23.6" • H 26"  
W 55.9 • D 59.9 • H 66.0 cm

365 lbs (165 kgs) daily at 70/50°F\*  
287 lbs (130 kgs) daily at 90/70°F\*

Model	Ice Type	Cooling	Electrical	Shipping Weight	Suggested List Price	Replaces Model
<b>RFP0320A-161★</b>	Flake	Air	115v/60hz/1	174 lbs (79 kgs)	<b>\$10,510</b>	RFF0320A-161
<b>RFK0320AZ-251</b>	Flake	Air	230v/50hz/1	174 lbs (79 kgs)	<b>\$10,681</b>	RFS0300AZ-251

**Recommended Bins:** D320 or D420 (See page 19-20).  
See pages 22-23 for required adapters.  
Use cleaner (000000084) only with this model.  
Price list performance rating is 60hz data.  
Not compatible with SPA/SFA dispensers, iAuCS, or LuminIce II.  
50 Hz Electric Connection: Add Z for Bare Lead cord.

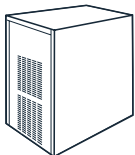

W 22" • D 23.6" • H 26 in  
W 55.9 • D 59.9 • H 66.0 cm

\*682 lbs (309 kgs) daily at 70/50°F\*  
\*527 lbs (239 kgs) daily at 90/70°F\*

Model	Ice Type	Cooling	Electrical	Shipping Weight	Suggested List Price	Replaces Model
<b>RFP0620A-161</b>	Flake	Air	115v/60hz/1	230 lbs (104 kgs)	<b>\$13,040</b>	RFF0620A-161
<b>RFP0620W-161</b>	Flake	Water	115v/60hz/1	230 lbs (104 kgs)	<b>\$13,826</b>	RFF0620W-161
<b>RFP0620AF-251</b>	Flake	Air	230v/50hz/1	230 lbs (104 kgs)	<b>\$13,238</b>	RFK0620AZ-251
<b>RFK0620WZ-251</b>	Flake	Water	230v/50hz/1	230 lbs (104 kgs)	<b>\$13,895</b>	RFS0650WZ-251

**Recommended Bins:** D320 or D420 (See page 19-20).  
See pages 22-23 for required adapters.  
Use cleaner (000000084) only with this model.  
Price list performance rating is 60hz data.  
Not compatible with SPA/SFA dispensers, iAuCS, or LuminIce II.  
50 Hz Electric Connection: Add Z for Bare Lead cord.

★ **ENERGY STAR® Qualified Model** | Air filter standard on self-contained air-cooled ice cube machines.

\* Daily ice production based on half dice air-cooled condenser model at air temperature/water temperature.

† Application storage capacity measured 90% of total volume in cubic feet. x 33 lbs / ft<sup>3</sup>

**MODULAR FLAKE (continued)**

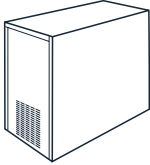

W 30" • D 23.6" • H 27.4"  
W 76.2 • D 59.9 • H 70.0 cm

1264 lbs (573 kgs) daily at 70/50°F\*  
951 lbs (431 kgs) daily at 90/70°F\*

**RFF1300**

Model	Ice Type	Cooling	Electrical	Shipping Weight	Suggested List Price	Replaces Model
RFF1300A-261	Flake	Air	208-230v/60hz/1	263 lbs (119 kgs)	\$19,254	RFS1200A-261
RFF1300W-261	Flake	Water	208-230v/60hz/1	263 lbs (119 kgs)	\$20,416	RFS1200W-261
RFK1300AZ-251	Flake	Air	230v/50hz/1	263 lbs (119 kgs)	\$19,704	RFS1200AZ-251
RFK1300WZ-251	Flake	Water	230v/50hz/1	263 lbs (119 kgs)	\$20,676	RFS1200WZ-251



**Recommended Bins:** D570, D970 (See page 19-20)  
See pages 22-23 for required adapters.  
Use cleaner (000000084) only with this model.  
Price list performance rating is 60hz data.  
Not compatible with SPA/SFA dispensers, iAuCS, or LuminIce® II  
50 Hz Electric Connection: Add Z for Bare Lead cord.

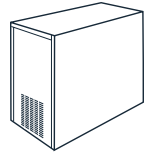

W 22" • D 23.6" • H 26"  
W 55.9 • D 59.9 • H 66.0 cm

1092 lbs (495 kgs) daily at 70/50°F\*  
958 lbs (435 kgs) daily at 90/70°F\*

**RFF1220**

Model	Ice Type	Cooling	Electrical	Shipping Weight	Suggested List Price	Replaces Model
RFF1220C-261	Flake	Remote	208-230v/60hz/1	186 lbs (84 kgs)	\$16,648	RFS1278C-261
RFS1278C-251	Flake	Remote	230v/50hz/1	186 lbs (84 kgs)	\$17,071	N/A



Requires RCUF1200 (60hz) or RJC 1275 (50hz) remote condensing unit and RC51 tubing kit. (see page 12)  
**Recommended Bins:** D420, D970. (See page 19-20)  
See pages 22-23 for required adapters.  
Use cleaner (000000084) only with this model.  
Price list performance rating is 60hz data.  
Not compatible with SPA/SFA dispensers, iAuCS, or LuminIce II.

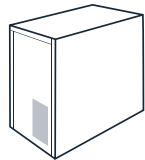

W 22" • D 23.6" • H 26"  
W 55.9 • D 59.9 • H 66.0 cm

1092 lbs (495 kgs) daily at 70/50°F\*  
958 lbs (435 kgs) daily at 90/70°F\*

**RFF2200**

Model	Ice Type	Cooling	Electrical	Shipping Weight	Suggested List Price	Replaces Model
RFF2200C-261	Flake	Remote	208-230v/60hz/1	279 lbs (127 kgs)	\$32,829	RFS2378C-261
RFS2378C-251	Flake	Remote	230v/50hz/1	279 lbs (127 kgs)	\$28,696	N/A

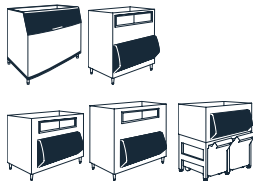

Requires RCUF2200 (60hz) or RJC2375 (50hz) remote condensing unit and RC51 tubing kit. (see page 12)  
**Recommended Bins:** D970, F1300, F1325, F1650, and FC1350  
(See page 19-20)  
See pages 22-23 for required adapters.  
Use cleaner (000000084) only with this model.  
Price list performance rating is 60hz data.  
Not compatible with SPA/SFA dispensers, iAuCS, or LuminIce II.



## COUNTERTOP NUGGET



**CNF0201:**

W 16.25" • D 24" • H 35"  
W 41.3 • D 61 • H 106.7 cm

315 lbs (143 kgs) daily at 70/50°F\*  
222 lbs (101 kgs) daily at 90/70°F\*



**CNF0202:**

W 16.25" • D 24" • H 42"  
W 41.3 • D 61 • H 106.7 cm

315 lbs (143 kgs) daily at 70/50°F\*  
222 lbs (101 kgs) daily at 90/70°F\*



**K00453: CNF Stand**

W 16.25" • D 24" • H 42"  
W 41.3 • D 61 • H 106.7 cm

315 lbs (143 kgs) daily at 70/50°F\*  
222 lbs (101 kgs) daily at 90/70°F\*

CNF0201 / 202

Model	Cooling	Use With	Electrical	Shipping Weight	Suggested List Price	Replaces Model
CNP0201A-161L	Nugget	Air	115v/60hz/1	184 lbs (127 kgs)	\$13,040	CNF0201A-161L
CNP0201A-161	Nugget	Air	115v/60hz/1	184 lbs (127 kgs)	\$13,340	CNF0201A-161
CNP0201A-161N	Nugget	Air	115v/60hz/1	184 lbs (127 kgs)	\$13,340	CNF0201A-161N
CNP0202A-161L	Nugget	Air	115v/60hz/1	198 lbs (90 kgs)	\$15,764	CNF0202A-161L
CNP0202A-161	Nugget	Air	115v/60hz/1	198 lbs (90 kgs)	\$16,064	CNF0202A-161
CNP0201A-251L	Nugget	Air	230v/50hz/1	184 lbs (127 kgs)	\$13,238	CNF0201A-251L
CNP0201A-251	Nugget	Air	230v/50hz/1	184 lbs (127 kgs)	\$13,585	CNF0201A-251
CNP0202A-251L	Nugget	Air	230v/50hz/1	198 lbs (90 kgs)	\$15,988	CNF0202A-251L
CNP0202A-251	Nugget	Air	230v/50hz/1	198 lbs (90 kgs)	\$16,335	CNF0202A-251

**Note Dispensing Type:** "-161L" is lever activated and "-161" is sensor activated.

3 dispensing options: ice, water, and ice/water together.

Bin capacity is 10 lbs / 4.5 kg for CNF0201 and 20 lbs (9 kgs) for CNF0202.

Legs sold separately, see kit K00345001 below.

**Use cleaner (000000084) only with this model.**

Not compatible with iAuCS. Price list performance rating is 60hz data.

**161N** is a solid front panel option, push buttons are covered to make machine completely touchless.

Kit	Description	Electrical	Shipping Weight	Suggested List Price
K00345001	Leg Kit (Adjustable: 4.5 in - 6.5 in / 11.43 - 16.5 cm)	—	3 lbs (1.3 kgs)	\$207
K00377	Kit to convert from lever activated to touchless sensing dispensing option	115/60/1	3 lbs (1.3 kgs)	\$679
K00524	Kit to convert from touchless sensing to lever activated dispensing option	—	3 lbs (1.3 kgs)	\$679
K00514	Solid Front panel replacement for CNF0201 or RNS12, covers buttons to make machine completely touchless	—	10 lbs (5 kgs)	\$401
K00515	Solid Front panel replacement for the CNF0202 or RNS20, covers buttons to make machine completely touchless	—	10 lbs (5 kgs)	\$401
K00453	CNF Stand	—	100 lbs (45.4 kgs)	\$1,570

K00453 has been rated to accommodate weight of 850 lbs. Can be used with the S-150 (without the legs) with either the iT0420 or iT620 Indigo NXT ice machine.

## UNDERCOUNTER NUGGET



W 19.69" • D 25.98" • H 33.17"  
W 50 • D 66 • H 84.3 cm

220 lbs (100 kgs) daily at 70/50°F\*  
164 lbs (74 kgs) daily at 90/70°F\*



W 29.06" • D 27.17" • H 39.52"  
W 73.8 • D 69 • H 100.4 cm

325 lbs (148 kgs) daily at 70/50°F\*  
286 lbs (130 kgs) daily at 90/70°F\*

UNP0200

Model	Ice Type	Cooling	Electrical	Shipping Weight	Suggested List Price	Replaces Model
UNP0200A-161★	Nugget	Air	115v/60hz/1	157 lbs (72 kgs)	\$11,077	UNF0200A-161
UNK0200AZ-251	Nugget	Air	230v/50hz/1	157 lbs (72 kgs)	\$11,254	RNS0244AZ-251

**Application ice storage capacity:** 30 lbs (14kgs). Measured cubic volume 1.03. Storage capacity is AHRI certified.

Application storage capacity measured 90% of total volume in cubic feet x 22 lbs / ft<sup>3</sup>

Includes 6 ft (1.8 m) power cord with NEMA 5-15P plug.

Use cleaner (000000084) only with this model.

Not compatible with iAuCS, LuminIce II, or casters.

Price list performance rating is 60hz data. 50 Hz Electric Connection:

Add Z for Bare Lead cord.

UNP0300

Model	Ice Type	Cooling	Electrical	Shipping Weight	Suggested List Price	Replaces Model
UNP0300A-161★	Nugget	Air	115v/60hz/1	224 lbs (102 kgs)	\$12,729	UNF0300A-161
UNK0300AZ-251	Nugget	Air	230v/50hz/1	224 lbs (102 kgs)	\$12,923	RNS0385AZ-251

**Application storage capacity:** 60 lbs / 27kg. Measured cubic volume 2.04. Storage capacity is AHRI certified.

Application storage capacity measured 90% of total volume in cubic feet x 22 lbs / ft<sup>3</sup>

Includes 6 ft (1.8 m) power cord with NEMA 5-15P plug.

Use cleaner (000000084) only with this model.

Not compatible with iAuCS, LuminIce II, or casters.

Price list performance rating is 60hz data.

50 Hz Electric Connection: Add Z for Bare Lead cord.

★ ENERGY STAR® Qualified Model | Air filter standard on self-contained air-cooled ice cube machines.

\* Daily ice production based on half dice air-cooled condenser model at air temperature/water temperature.

# MODULAR NUGGET

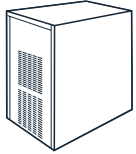

W 22" • D 23.6" • H 26"  
W 55.9 • D 60 • H 66 cm

300 lbs (136 kgs) daily at 70/50°F\*  
259 lbs (117 kgs) daily at 90/70°F\*

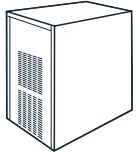

W 22" • D 23.6" • H 26"  
W 55.8 • D 60 • H 66 cm

575 lbs (261 kgs) daily at 70/50°F\*  
463 lbs (210 kgs) daily at 90/70°F\*

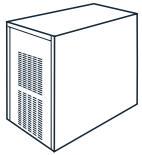

### RNF100

W 30" • D 23.62" • H 27.36"  
W 76.2 • D 60 • H 69.5 cm  
1078 lb (489 kgs) daily at 70/50°F\*  
825 lb (374 kgs) daily at 90/70°F\*

### RNF1020C

W 22" • D 23.62" • H 27.36"  
W 55.8 • D 60 • H 69.5 cm  
1116 lb (506 kgs) daily at 70/50°F\*  
900 lb (408 kgs) daily at 90/70°F\*

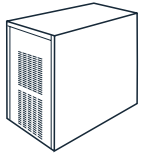

### RNF2000C

W 30" • D 23.6" • H 27.4"  
1915 lbs (868 kgs) daily at 70/50°F\*  
1475 lbs (669 kgs) daily at 90/70°F\*

Model	Ice Type	Cooling	Electrical	Shipping Weight	Suggested List Price	Replaces Model
RNP0320A-161★	Nugget	Air	115v/60hz/1	174 lbs (79 kgs)	\$10,761	RNF0320A-161
RNK0320AZ-251	Nugget	Air	230v/50hz/1	174 lbs (79 kgs)	\$10,935	RNS0308AZ-251

**Recommended Bins:** D320 or D420 (see page 19-20) See page 22-23 for required adapters. Use cleaner (000000084) only with this model. All dispenser manufacturers require a nugget ice adapter kit and ice level management kit. Contact beverage dispenser manufacturer or use kit K00488 ice level management kit. Not for use with SPA/SFA dispensers, iAuCS, or LuminIce II. 50 Hz Electric Connection: Add Z for Bare Lead cord.

Model	Ice Type	Cooling	Electrical	Shipping Weight	Suggested List Price	Replaces Model
RNP0620A-161	Nugget	Air	115v/60hz/1	210 lbs (95 kgs)	\$13,266	RNF0620A-161
RNP0620W-161	Nugget	Water	115v/60hz/1	210 lbs (95 kgs)	\$14,067	RNF0620W-161
RNK0620AZ-251	Nugget	Air	230v/50hz/1	210 lbs (95 kgs)	\$13,467	RNS0608A-251
RNK0620WZ-251	Nugget	Water	230v/50hz/1	210 lbs (95 kgs)	\$14,137	RNS0609W-251

**Recommended Bins:** D420 or D570 (see page 19-20) D-570 will require an adapter, see pages 22-23. All dispenser manufacturers require a nugget ice adapter kit and ice level management kit. Contact beverage dispenser manufacturer or use kit K00488 ice level management kit. Not compatible with SPA/SFA dispensers, iAuCS, or LuminIce II. 50 Hz Electric Connection: Add Z for Bare Lead cord.

Model	Ice Type	Cooling	Electrical	Shipping Weight	Suggested List Price	Replaces Model
RNF1100A-261	Nugget	Air	208-230v/60hz/1	275 lbs (125 kgs)	\$19,962	RNS1008A-261
RNF1100W-261	Nugget	Water	208-230v/60hz/1	275 lbs (125 kgs)	\$21,165	RNS1009W-261
RNF1020C-161	Nugget	Remote	115v/60Hz/1	195 lbs (88 kgs)	\$18,853	RNS1078C-161
RNK1100AZ-251	Nugget	Remote	230v/50hz/1	275 lbs (125 kgs)	\$20,419	RNS1008AZ-251

**Recommended Bins:** D970, F700, F1300, F1325, F1650, FC1350 (see page 19-20) See page 22-23 for required adapters. Requires RCUF1000 remote condensing unit and RC51 tubing kit. Use cleaner (000000084) only with this model. All dispenser manufacturers require a nugget ice adapter kit and ice level management kit. Contact beverage dispenser manufacturer or use kit K00488 ice level management kit. Not compatible with SPA/SFA dispensers, iAuCS, or LuminIce II. 50 Hz Electric Connection: Add Z for Bare Lead cord.

Model	Ice Type	Cooling	Electrical	Shipping Weight	Suggested List Price	Replaces Model
RNF2000C-261	Nugget	Remote	208-230v/60hz/1	279 lbs (127 kgs)	\$25,749	N/A

**Recommended Bins:** D970, F700, F1300, F1325, F1650, FC1350 (see page 19-20). Requires RCUF2200 remote condensing unit and RC51 tubing kit. Use cleaner 000000084 only with this model. All dispenser manufacturer require a nugget ice adapter kit and ice level management kit. Contact beverage dispenser manufacturers or use kit K00488 ice level management kit. Not compatible with SPA/SFA dispensers, iAuCS, or LuminIce II.

★ ENERGY STAR® Qualified Model | Air filter standard on self-contained air-cooled ice cube machines.

\* Daily ice production based on half dice air-cooled condenser model at air temperature/water temperature.

## HOTEL DISPENSERS



**ADA Compliant**  
W 22" • D 31.19" • H\* 54"  
W 55.9 • D 78.7 H\* • 137.2 cm

### SPA 162 / SFA 192 SERIES

Model	Application Capacity	Electrical	Shipping Weight	Suggested List Price	Replaces Model
SPA162-161	120 lbs (54 kgs) of storage	115v/60Hz/1	165 lbs (75 kgs)	\$9,653	SPA160-161
SPA162-261	120 lbs (54 kgs) of storage	208-230v/60Hz/1	165 lbs (75 kgs)	\$9,728	SPA160-261
SFA192-161	120 lbs (54 kgs) of storage	115v/60Hz/1	168 lbs (76 kgs)	\$11,149	SFA 191-161
SPA162-251	120 lbs (54 kgs) of storage	230v/50Hz/1	165 lbs (75 kgs)	\$9,727	SPA160-251
SFA192-251	120 lbs (54 kgs) of storage	230v/50Hz/1	165 lbs (75 kgs)	\$11,223	SFA191 -251

SPA162 and SFA192 has Touchless lever ice chute dispense mechanism with push rod. Height adjustable [6 - 7.5 in (15.2 - 19cm)] stainless steel legs included. Accepts single 22 in (55.9cm) Dice or Half Dice size ice machines no larger than IT0620 (order separately) Indigo NXT 22 in (55.9 cm) requires K0034800 baffle (included with dispenser). Dispenser requires separate electrical outlet from the ice machine. SFA models include water valve. Touch-less lever kit K00497 and K00523 kit with push rod are available to upgrade older units (see page 23)  
-161 version comes with a 6 ft (1.8m) power cord with NEMA 5-15P plug ("B" Plug).



**ADA Compliant**  
W 30" • D 32" • H\* 60.5"  
W 76.2 • D 81.3 H\* • 153.7 cm

### SPA 312 / SFA 292 SERIES

Model	Application Capacity	Electrical	Shipping Weight	Suggested List Price	Replaces Model
SPA312-161	180 lbs / 82 kg of storage	115v/60Hz/1	209 lbs (95 kgs)	\$11,377	SPA310-161
SPA312-261	180 lbs (82 kgs) of storage	208-230v/60Hz/1	209 lbs (95 kgs)	\$11,452	SPA310-261
SFA292-161	180 lbs / 82 kg of storage	115v/60Hz/1	214 lbs (97 kgs)	\$12,615	SFA291-161
SPA312-251	180 lbs / 82 kg of storage	230v/50Hz/1	209 lbs (95 kgs)	\$11,452	SPA310-251
SFA292-251	180 lbs / 82 kg of storage	230v/50Hz/1	214 lbs (97 kgs)	\$12,691	SFA291-251

SPA312 and SFA292 has Touchless lever ice chute dispense mechanism. Height adjustable [6 - 7.5 in (15.2 - 19 cm)] stainless steel legs included. Accepts single 22 in (55.9cm)(K00472 adapter required) or 30 in (6.2 cm) Dice or Half Dice size ice machines no larger than IT0750 (order separately) Indigo NXT 30 in (76.2cm) requires K00346 baffle (included with dispenser). Dispenser requires separate electrical outlet from the ice machine. SFA models includes water valve. Touch-less lever kit K00497 and K00523 kit with push rod are available to upgrade older units (see page 23)  
-161 version comes with a 6 ft (1.8m) power cord with NEMA 5-15P plug ("B" Plug).

\*Includes 6" (15.2 cm) adjustable leg

## ICE STORAGE BINS



**D320**  
W 22" D 34" H 38"  
W 55.9 D 86.4 H 96.5 cm

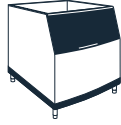

**D400**  
W 30" D 34" H 38"  
W 76.2 D 86.4 H 96.5 cm



**D420**  
W 22" D 34" H 50"  
W 55.9 D 86.4 H 127.0 cm



**D570**  
W 30" D 34" H 50"  
W 76.2 D 86.4 H 127.0 cm

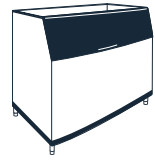

**D970**  
W 48" D 34" H 50"  
W 121.9 D 86.4 H 127.0 cm

Height includes bin legs set at 6 in / 15.2 cm.

	Model	Application Capacity	2018 AHRI Capacity Cu ft (Cu m)	Shipping Weight	Suggested List Price	Replaces Model
D-STYLE BINS	D320	264 lbs (119 kgs)	8.9 (0.25)	75 lbs (34 kgs)	<b>\$3,351</b>	B320
	D400	365 lbs (165 kgs)	12.3 (0.37)	91 lbs (41 kgs)	<b>\$3,484</b>	B400
	D420	383 lbs (172 kgs)	12.9 (0.35)	108 lbs (49 kgs)	<b>\$3,661</b>	B420
	D570	532 lbs (241 kgs)	17.9 (0.51)	115 lbs (52 kgs)	<b>\$4,022</b>	B570
	D970	882 lbs (400 kgs)	29.7 (0.84)	150 lbs (68 kgs)	<b>\$5,576</b>	B970



One set of stainless steel legs included in bin price for D-Series bin. Height includes bin legs set at 6 in / 15.2 cm. Legs adjust from 6 - 7.5 in (15.2 - 19.7cm). For bin adapters and ice deflectors, please see page 23

**Application Capacity** - measured 90% of the total volume in cu. ft x 33 lbs/ft<sup>3</sup>. 2018 AHRI Capacity is the total internal volume measured in cu. ft.



## Ice Storage Bins



**F700**

W 30" (76.2 cm)  
D 31" (78.74 cm)  
H 60" (152.4 cm)

F-STYLE BINS	Model	Application Capacity	2018 AHRI Capacity (Cu ft / Cu m)	Shipping Weight	Suggested List Price	Replaces Model
	F700	639 lbs (290 kgs)	21.5 (0.61)	195 lbs (88 kgs)	\$10,041	LB0730
	F1300	1194 lbs (542 kgs)	40.2 (1.14)	292 lbs (132 kgs)	\$13,612	LB1448
	F1325	1238 lbs (562 kgs)	41.7 (1.18)	300 lbs (136 kgs)	\$14,012	LB1460
	F1325-3030	1238 lbs (562 kgs)	41.7 (1.18)	300 lbs (136 kgs)	\$15,891	LB1460-3030
	F1650	1494 lbs (678 kg)	50.3 (1.42)	327 lbs (148 kgs)	\$15,264	LB1760
	FC1350	1304 lbs (591 kgs)	43.9 (1.24)	700 lbs (318 kgs)	\$39,470	LBCS1360

NOTE: F1325-3030 includes K603030 adapter for two 30" ice machines



**F1300**

W 48" (121.92 cm)  
D 31" (78.74 cm)  
H 65" (165.1 cm)

ACCESSORIES	Model	Accessory Description	Shipping Weight	Suggested List Price
	K00412	46.5" / 118.1 cm NSF Paddle	5 lbs (2 kgs)	\$583
	K00414	37" / 94 cm NSF Shovel	10 lbs (5 kgs)	\$570
	K00416	Replacement Set of 6 NSF Totes (16 lb each)	34 lbs (15 kgs)	\$1,350
	K00418	Replacement 207 lbs. NSF Ice Cart	75 lbs (34 kgs)	\$4,430
	K00419	58.5" / 148.6 cm NSF Paddle	6 lbs (3 kgs)	\$583

NOTES:  
K00418 - replacement cart does not include totes or spacer. Totes and spacer sold separately.  
Capacity without spacer and totes ~ 207 lbs. K00416 set of 6 totes, each hold 16 lbs. or 96 lbs total / cart.



**F1325**

W 60" (152.4 cm)  
D 31" (78.74 cm)  
H 56" (142.24 cm)



**F1650**

W 60" (152.4 cm)  
D 31" (78.74 cm)  
H 65" (165.1 cm)



**FC1350**

W 60" (152.4 cm)  
D 40" (101.6 cm)  
H 75" (190.5 cm)

## Bin Adapters

Ice Maker Model	Width	30"	30"	30"	30"	30"	48"	22"	30"	36.7"	48"	
Bin Adapter Model No.	Ice Makers on bin	Bin Width	i0500, i0500N	i0600N, i0750	i0900N, i1200	i0600C, i0900C, i1200C	i1400/ i1430, i1800/ i1830, i2100/ i2130	i1500, i1900	RN0320, RN1020C, RNF0620, RFF0320, RF0620, RFF1220	RF2500, RN2000C	RF2500	S3000W, S3000C
F700	1	30"	K303000 Single head Adapter (included with bin)				N/A	+K302200	K303000 included	N/A	N/A	
F1300	1	48"	K483048 Single head Adapter (included with Bin)				N/A	N/A	K483048 included with bin			
F1325	1	60"	K603048 Single head Adapter (included with Bin)				N/A	N/A	K603048 included with bin		+K604800	
F1650	2 <sup>†</sup>	60"	K603030 Side-by-Side 30" Head Adapter				N/A	+K00421 & K-603030	+K603030	N/A	N/A	
FC1350	1	60"	K613048 Single head Adapter (included with Bin)				N/A	N/A	K613048 included with bin		+K614800	
	2 <sup>†</sup>	60"	K613030 Side-by-Side 30" Head Adapter				N/A	+K00421 & K-613030	+K603030	N/A	N/A	

\*Application Capacity-measured 90% of the total volume in cu. ft. x 33 lbs/ft<sup>3</sup>.

<sup>†</sup>For side by side application use with water-cooled, or ice machines with top air discharge option.

Check machine clearance requirements.

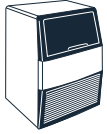

W45 • D47.5 • H65 cm  
**UGP00200A**  
 22 kgs daily at 21/10°C  
 16.6 kgs daily at 32/21°C  
**UGP0030A**  
 31 kgs daily at 21/10°C  
 25.3 kgs daily at 32/21°C

	Model	Ice Type	Cooling	Electrical	Shipping Weight	Suggested List Price	Replaces Model
UG30 / UG20	UGP0020A-251Z	Gourmet	Air	230v/50/Hz/1	45 kg (99 lbs)	\$3,700	UG020A-251
	UGP0030A-251Z	Gourmet	Air	230v/50/Hz/1	45 kg (99 lbs)	\$3,820	UG030A-251
	UGE0020A-261Z	Gourmet	Air	208-230v/60Hz/1	45 kg (99 lbs)	\$3,700	N/A

Ice Storage Capacity 10 kg. 50 Hz Electric Connection Options: Add letter to end of model number – Z for Bare Lead, F for Schuko Plug, G for Blade Plug and I for Oblique Flat Blade Plug. 60 Hz models offered in Z for Bare Lead. 60Hz 115v add B for grounded power cord. Price list performance rating is 50hz data. Refer to individual 60hz spec sheets for 60hz performance rating. Use cleaner (000006036) only with this model. Not for use with iAuCS cleaning system. Optional Leg Kit K00345001 Contact your local distributor for pricing.

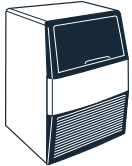

W55 • D55 • H80 cm  
**UGP0040A**  
 45 kgs daily at 21/10°C  
 36 kgs daily at 32/21°C  
**UGP0050A**  
 55.3 kgs daily at 21/10°C  
 43 kgs daily at 32/21°C

	Model	Ice Type	Cooling	Electrical	Shipping Weight	Suggested List Price	Replaces Model
UG40 / UG50	UGP0040A-251Z	Gourmet	Air	230v/50/Hz/1	59 kgs (130 lbs)	\$4,595	UG040A-251
	UGP0050A-251Z	Gourmet	Air	230v/50/Hz/1	60 kgs (132 lbs)	\$4,768	UG050A-251
	UGF0040A-261Z	Gourmet	Air	208-230v/60Hz/1	59 kgs (130 lbs)	\$4,595	N/A
	UGF0050A-161B	Gourmet	Air	115v/60Hz/1	60 kgs (132 lbs)	\$4,768	N/A
	UGF0050A-261Z	Gourmet	Air	208-230v/60Hz/1	60 kgs (132 lbs)	\$4,768	N/A

Ice Storage Capacity 25 kg. 50 Hz Electric Connection Options: Add letter to end of model number – Z for Bare Lead, F for Schuko Plug, G for Blade Plug and I for Oblique Flat Blade Plug. 60 Hz models offered in Z for Bare Lead. 60Hz 115v add B for grounded power cord. Price list performance rating is 50hz data. Refer to individual 60hz spec sheets for 60hz performance rating. Use cleaner (000006036) only with this model. Not for use with iAuCS cleaning system. Optional Leg Kit K00345001 Contact your local distributor for pricing.

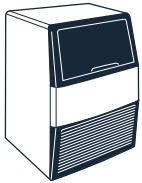

W70 • D60 • H90cm  
**UGP0080A**  
 86.4 kgs daily at 21/10°C  
 67.5 kgs daily at 32/21°C

	Model	Ice Type	Cooling	Electrical	Shipping Weight	Suggested List Price	Replaces Model
UG80	UGP0080A-251Z	Gourmet	Air	230v/50/Hz/1	72 kgs (159 lbs)	\$5,644	UG080A-251
	UGF0080A-261Z	Gourmet	Air	208-230v/60Hz/1	72 kgs (159 lbs)	\$5,644	N/A

Ice Storage Capacity 44 kg, 50 Hz Electric Connection Options: Add letter to end of model number – Z for Bare Lead, F for Schuko Plug, G for Blade Plug and I for Oblique Flat Blade Plug. 60 Hz models offered in Z for Bare Lead. Price list performance rating is 50hz data. Refer to individual 60hz spec sheets for 60hz performance rating. Use cleaner (000006036) only with this model. Not for use with iAuCS cleaning system. Optional Leg Kit K00345001 Contact your local distributor for pricing.

## BIN ADAPTERS & ICE DEFLECTOR KITS

Kit	Description	Shipping Weight	Suggested List Price
K00195	Bin Adapter: for 22"/55.9 cm IB series ice machines on a 22"/55.9 cm D320 or D420 or 22"/55.9 cm Hotel Dispenser	10 lbs (4.5 kgs)	\$574
K00196	Bin Adapter: for 22"/55.9 cm IB series ice machines on a 30"/72.6 cm D400 or D570 or a 30"/72.6 cm Hotel Dispenser	15 lbs (7 kgs)	\$622
K00472	Bin Adapter: for 22"/55.9 cm Indigo NXT, RFF, RNF ice machines on a 30"/70.6 cm D 400, 570 or 30"/72.6 cm Hotel Dispenser. Not for IB	8 lbs (4 kgs)	\$508
K00473	Bin Adapter: for 22"/55.9 cm Indigo NXT, RFF, RNF on a D970 bin. Not for IB	35 lbs (16 kgs)	\$852
K00371	Bin Adapter for two 22"/55.9 cm RFP,RNP (water or QQ) or Indigo NXT (with Top air discharge or water cooled) on a D970 bin.	8 lbs (4 kgs)	\$456
K00470	Bin Adapter: for 30"/76.2 cm Indigo NXT, RFF, RNF ice machines on a 48"/121.9 cm D970 Bin	34 lbs (15 kgs)	\$852
K00471	Front and center deflector for 30"/76.2 dual ice machines, IF1400C, 1800C or 2100C on a 48" /121.9 cm D970 Bin. (Must also use the K00470) Remove the existing deflector in the D970 prior to installing	13 lbs (6 kgs)	\$508
K00382	Ice Deflector required for 30" (72.6 cm) for I1400C, I1800C, or I2100C on a Non-Manitowoc or F-Style Bin	8 lbs (4 kgs)	\$315
K00383	Ice Deflector required for: two 30"/72.6 cm for I1400C, I1830C or I2100C on a non-Manitowoc or LB & F-style Bin	18 lbs (8 kgs)	\$525
K00347	Ice Deflector required for: 30"/76.2 cm Indigo NXT with front facing evaporators on a non-Manitowoc or LB & F-style Bin	5 lbs (3 kgs)	\$311
K0034900	Ice Deflector required for: 48"/121.9 cm Indigo NXT on a non-Manitowoc or LB & F-style Bin	10 lbs (5 kgs)	\$366
K00391	Ice Deflector set required for S3000 ice machine on a non-Manitowoc or 48"/121.9 cm or 60" /152.4 cm LB & F-style Bin	18 lbs (8 kgs)	\$1,018
K00420	Filler Panel Kit allows 22"/55.9 cm RNF1020C to be places on a F-style bin with 48" and 60" opening (for use with adapter included with bin)	5 lbs (3 kgs)	\$318
K00421	Filler Panel Kit allows for two side by side 22" /55.9 cm RNF1020C to be place on a F -style bins with 60"/152.4 cm opening	5 lbs (3 kgs)	\$318
K302200	Bin Adapter for 22" / 55.9 cm RFP/RFF or RNP/RNF on F-700 bin	45 lbs (20 kgs)	\$1,626
K303000	Replacement Bin Adapter for 30"/76.2 cm Indigo NXT Series Cuber on a F700 Bin (Included with bin)	45 lbs (20 kgs)	\$1,626
K483048	Replacement Bin Adapter for 30"/76.2 cm and 48"/121.9 cm Indigo NXT Series Cuber on a F1300 Bin (Included with bin)	45 lbs (20 kgs)	\$2,031
K603048	Replacement Bin Adapter for 30"/76.2 cm and 48"/121.9 cm Indigo NXT Series Cuber on a F1325 or F1650 Bin (included with the bin)	52 lbs (24 kgs)	\$2,636
K604800	Bin Adapter for SF3000C & ST3000W on a F1325 or F1650 Bin	52 lbs (24 kgs)	\$2,760
K603030	Bin Adapter for two 30"/ 76.2 cm Indigo NXT Series Cubers Side by Side on a F1325 or F1650 Bin (remote or water cooled)	52 lbs (24 kgs)	\$2,636
K613030	Bin adapter for two 30" / 76.2 cm Cuber units side-by-side on F-1350 bin	60 lbs (27 kgs)	\$3,444
K613048	Replacement bin adapter for 30" / 76.2 cm & 121.9 cm Indigo Cuber on F-1350 bin (included with bin)	60 lbs (27 kgs)	\$3,444
K614800	Bin adapter for S-3070C & S-3300 on F-1350 bin	60 lbs (27 kgs)	\$3,694
K00396	Filler Panel for SF3000C or ST3000W on a LB1448	5 lbs (3 kgs)	\$318
K00513	Ice Deflector required for 30" (72.6 cm) for I1400C, I1800C, or I2100C on LB730, LB1448, LB1460, LB1760. (1 inch longer than the K00382 due to the opening size on the tops being larger than others)	5 lbs (3 kgs)	\$318
K00506	Replacement Filler Panels for 22 inch machine on a LB0730 (included with bin)	5 lbs (3 kgs)	\$372
K00508	Replacement Filler Panels for 22 inch machine on a LB1448/1460/1760 (included with bin)	5 lbs (3 kgs)	\$372
K00509	Replacement Filler Panels for 30 inch machine on a LB0730 (included with bin)	5 lbs (3 kgs)	\$412
K00510	Replacement Filler Panels for 22 inch machine on a LB0730 (included with bin)	5 lbs (3 kgs)	\$372
KLB302230	Replacement Bin Adapter for 22" /55.9 cm and 30"/76.2 cm Indigo NXT, RFF or RNF on a LB730 Bin (included with bin)(adapter is included with bin- the replacement consist of the poly top adapter and the metal under frame)	40 lbs (18 kgs)	\$1,693
KLB482214	Required bin adapter for 2-22"/55.9 cm Ice Beverage (IB) side by side on LB1448	45 lbs (20 kgs)	\$2,399
KLB604800	Required Bin Adapter for SF3000C & ST3000W on a LB1460 or LB1760 Bin	74 lbs (34 kgs)	\$2,399
KLB602222	Required Bin Adapter for 2-22" / 55.9 cm side by side Quite Qube Indigo NXT, RFF or RNF, water cooled Indigo NXT, RFF or RNF or Indigo NXT air cooled with top air discharge on a LB1460 or LB1760	52 lbs (24 kgs)	\$2,399
KLB602214	Required Bin Adapter for 2-22" / 55.9 cm Ice Beverage (IB) side by side on a LB1460 or LB1760	52 lbs (24 kgs)	\$2,399
KLB603030	Required Bin Adapter for 2-30"/76.2 cm Indigo NXT side by side on LB1460 or LB1760 Bins (remote, water cooled or Top Air discharge)	60 lbs (27 kgs)	\$1,879
KLB613048	Replacement Bin Adapter for 22"/55.9 cm 30"/76.2 cm or 48"/121.9 cm Indigo NXT RNF or RNF on a LB0730 (included with bin)(adapter is included with bin- the replacement consist of the poly top adapter and the metal under frame)	60 lbs (27 kgs)	\$1,831
KLB614800	Required Bin Adapter for SF3000C & ST3000W on a LB0730 Bin	77 lbs (35 kgs)	\$2,535
KLB612214	Required Bin Adapter for 2-22" / 55.9 cm side by side Ice Beverage (IB) on a LB0730	60 lbs (27 kgs)	\$2,535
KLB612222	Required Bin Adapter for 2-22" / 55.9 cm side by side Quite Qube Indigo NXT, RFF or RNF, water cooled Indigo NXT, RFF or RNF or Indigo NXT air cooled with top air discharge on a LB0730	60 lbs (27 kgs)	\$2,535
KLB613030	Required Bin Adapter for 2- 30" / 76.2 cm Indigo NXT, RFF or RNF side by side on a LB0730 Bins (remote, water cooled or Indigo NXT with Top Air Discharge)	60 lbs (27 kgs)	\$2,535
K00457	DISPENSER THERMOSTAT KIT – For use with S-Series. For use on Soda dispensers only. An ice dispenser thermostat kit may be required for high humidity locations to reduce equipment sweating. Replaces K00364.	3 lbs (1 kgs)	\$567
K00446	DISPENSER THERMOSTAT KIT – For use with Indigo Series only on Soda dispensers. An ice dispenser thermostat kit may be required for high humidity locations to reduce equipment sweating.	4 lbs (2 kgs)	\$368
K00477	DISPENSER THERMOSTAT KIT – For use with Indigo NXT series only on soda dispensers. An ice dispenser thermostat kit may be required for high humidity locations to reduce equipment sweating.	4 lbs (2 kgs)	\$368
K00456	DISPENSER THERMOSTAT KIT – For use with Indigo Series only on Freestyle beverage dispensers. An ice dispenser thermostat kit may be required for high humidity locations to reduce equipment sweating.	3 lbs (1 kgs)	\$354
K00478	DISPENSER THERMOSTAT KIT – For use with Indigo NXT Series only on Freestyle beverage dispensers. An ice dispenser thermostat kit may be required for high humidity locations to reduce equipment sweating.	3 lbs (1 kgs)	\$354

## MISCELLANEOUS

Kit	Description	Shipping Weight	Suggested List Price
K00488	DISPENSER THERMOSTAT KIT – For use with nugget machines on soda dispensers. An ice dispenser thermostat kit may be required for high humidity locations to reduce equipment sweating.	3 lbs (1 kgs)	\$567
K00346	DISPENSER BAFFLE - required for use with any Manitowoc 30" / 76.2 cm Indigo NXT series ice machine in a soda dispenser application. Dispenser baffle included with S-Series hotel dispensers, no need to order. NOT required for iF1400C and iF1800C.	3 lbs (1 kgs)	\$127
K0034800	DISPENSER BAFFLE – required for use with any Manitowoc 22" / 55.9 cm Indigo NXT Series ice machine in a Soda dispensers application. Dispenser baffle is included with S-Series Hotel dispensers, no need to order.	3 lbs (1 kgs)	\$143
K00395	S3000 BIN THERMOSTAT KIT – For use with S3000.	3 lbs (1 kgs)	\$819
K00483	DISPENSER THERMOSTAT KIT – for use with nugget machines on Freestyle 9000. An ice dispenser thermostat kit may be required for high humidity locations to reduce equipment sweating.	4 lbs (2 kgs)	\$1,111
K00487	DISPENSER THERMOSTAT KIT - for use with nugget machines on Freestyle 9100. An ice dispenser thermostat kit may be required for high humidity locations to reduce equipment sweating.	4 lbs (2 kgs)	\$702
K00497	TOUCHLESS LEVER ACTIVATED ICE CHUTE – Updates the Push to Touch SPA's and SFA's to Touchless. Use for buckets, tumblers and water bottles.	3 lbs (1 kgs)	\$240
K00522	SPA TO SFA CONVERSION KIT – Converts a SPA to an SFA Hotel Dispenser. Works with 22" and 30" SPA Hotel Dispensers	5 lbs (2 kgs)	\$785
K00523	Use to update "Push for ice" chutes to Touchless lever activated chute for SPA and SFA hotel Dispenser. Use with ice buckets and water bottles	3 lbs (1 kgs)	\$280
K00526	Required for 30" Indigo NXT Twin Evaporator ice machine heads (iF1400C, iT1430, iT1830, iF2100) on top of a Cornelius ProGate IDC255 Dispenser	1 lb (0.5 kg)	\$168

## BIN ADAPTERS & DEFLECTORS

ICE STORAGE BINS	BIN	Machines	IT0420, IT0620	IT0300	IT0450, IT0500, IF0500N	IF0600N, IT0750, IF0900N, IT0900	IT1200	IT1500, IT1900
	D320	1		N.A.	N.A.	N.A.	N.A.	N.A.
	D400	1	K00472					N.A.
	D420	1		N.A.	N.A.	N.A.	N.A.	N.A.
	D570	1	K00472					N.A.
	D970	1	K00473	K00470	K00470	K00470	K00470	N.A.
		2	K00371	N.A.	N.A.	N.A.	N.A.	N.A.
	F700 / LB0730	1	N.A.	N.A.	K00347	K00347	K00347	N.A.
	F1300 / LB1448	1	N.A.	N.A.	K00347	K00347	K00347	K0034900
	F1325 / LB1460	1	N.A.	N.A.	K00347	K00347	K00347	K0034900
F1650 / LB1760	1	N.A.	N.A.	K00347	K00347	K00347	K0034900	
FC1350 / LBCS1360	1	N.A.	N.A.	K00347	K00347	K00347	K0034900	
SPA162, SFA192	1		N.A.	N.A.	N.A.	N.A.	N.A.	
SPA312, SFA292	1	K0034800 & K00472				N.A.	N.A.	
<b>Non-Manitowoc Dispensers</b>	1	K0034800 (baffle)	K00346 (baffle)	K00346 (baffle)	K00346 (baffle)	K00346 (baffle)	N.A.	

N.A. means not a practical application or no adapter option available

ICE STORAGE BINS	BIN	Machines	IF0600C, IF0900C, IT1200C	IF1400C, IT1830C, IF2100C	IBF0620C, IFB0820C, IBT1020C	RNF, RFF0320, RNF, RFF0620, RNF1020C, RFE1220C	RFF1300, RNF1100, RNF2000C, RFF2200C	ST3000W, SF3000C
	D320	1	N.A.	N.A.	K00195		N.A.	N.A.
	D400	1		N.A.	K00196	K00472	N.A.	N.A.
	D420	1	N.A.	N.A.	K00195		N.A.	N.A.
	D570	1		N.A.	K00196	K00472	N.A.	N.A.
	D970	1	K00470	K00470, K00471	N.A.	K00473	K00470	N.A.
		2	N.A.	N.A.	N.A.	K00371	N.A.	N.A.
	F700	1	K00347	K00382	N.A.	N.A.		N.A.
	LB0730	1	K00347	K00382	N.A.			N.A.
	F1300	1	K00347	K00382	N.A.	N.A.		K00391
LB1448	1	K00347	K00513	N.A.			K00391, K00396	
	2	N.A.	N.A.	N.A.	N.A.	N.A.	N.A.	
F1325, F1650	1	K00347	K00382	N.A.			K00391, K604800	
	2	K00347(2), K603030	K00383, K603030	N.A.	K00421 & K603030	K603030	N.A.	
LB1460, LB1760	1	K00347	K00513	N.A.			K00391, KLB604800	
	2	K00347(2), KLB603030	K00383, KLB603030	KLB602214	KLB602222	KLB603030	N.A.	
FC1350	1	K00347	K00382	N.A.			K00391, K614800	
	2	K00347(2), K613030	K00383, K613030	N.A.	K00421, K613030	K613030	N.A.	
LBCS1360	1	K00347	K00382	N.A.			K00391, KLB614800	
	2	N.A.	N.A.	KLB612214	KLB612222	N.A.	N.A.	
SPA162, SFA192	1	N.A.	N.A.	K00195	N.A.	N.A.	N.A.	
SPA312, SFA292	1	N.A.	N.A.	K00196	N.A.	N.A.	N.A.	
<b>Non-Manitowoc Dispensers</b>	1	K00346 (baffle)	N.A.	N.A.	N.A.	N.A.	N.A.	

NOTE: Adapter included with single head application unless otherwise indicated. Deflectors are required for F and LB bins. N.A. means not a practical application or no adapter option available.



ACCESSORIES

Accessory prices are now included in the standard equipment suggested price list.

QUIET TUBE & IB REMOTE TUBING KITS & ACCESSORIES

Kit	Description	Shipping Weight	Suggested List Price
<b>iAuCS® AUTOMATIC CLEANING SYSTEM</b>			
<b>IAUCS-161</b> <b>IAUCS-261</b>	Automatic Cleaning System Accessory <b>for all Indigo and Indigo NXT Series ice machines 300 to 2100.</b> Cannot be used with Indigo IB Series, S-Series, nugget, flake and undercounter units. This option is installed on the outside of the machine and works in conjunction with cleaner and sanitizer bottle numbers 000005162 or 000005164. Installed outside of machine but electrical is supplied from the machine. When ordering, indicate electrical requirements; 115 volt 60 Hz -iAuCS-161, and 230 volt 60 Hz - iAuCS-261.	11 lbs (5 kgs)	<b>\$1,239</b>
<b>IBAUCS-161</b>	Automatic Cleaning System Accessory <b>for Indigo IB Series ice machines: IBF0620C, IBF0820C, IBT1020C.</b> Cannot be used with Indigo Series ice machines 300 to 2100, S-Series, nugget, flake and undercounter units. This option is installed on the outside of the machine and works in conjunction with cleaner and sanitizer bottle numbers 000005162 or 000005164. Installed outside of machine. Electrical requirements 115 volt 60 Hz. Includes 10' power cord with NEMA 5-15P plug.	11 lbs (5 kgs)	<b>\$1,239</b>
<b>NOTE:</b> iAuCS Automatic Cleaning System cannot be used with flake and nugget ice machines.			
<b>LUMINICE® II VIRUS AND BACTERIA INHIBITOR</b>			
<b>K00450</b>	LuminIce II Virus and Bacteria Inhibitor kit for Indigo units i300 to i1106 and QQ models	5 lbs (2.2 kgs)	<b>\$935</b>
<b>K00519</b>	LuminIce II Virus and Bacteria Inhibitor kit for NEO Undercounters UF0140 to UF0310 (Replaces K00452)	5 lbs (2.2 kgs)	<b>\$935</b>
<b>K00464</b>	LuminIce II Virus and Bacteria Inhibitor kit for Indigo NXT models: iT0300, iT420, iT620, iT450, iT500, iF0600, iT0750, iF0900, iT1200 and QQ iF0600C, iF0900C, iT1200C	5 lbs (2.2 kgs)	<b>\$935</b>
<b>K00465</b>	LuminIce II Virus and Bacteria Inhibitor kit for Indigo NXT models: iT1500 & iT1900 and IBF0620C, IBF0820C, IBT1020C and iF1400C, iT1830C, iF2100 (Indigo NXT 48 in, IB's, Duals)	5 lbs (2.2 kgs)	<b>\$935</b>
<b>K00474</b>	Converts K00450 or K00451 to work with appropriate Indigo NXT model	0.5 lbs (0.23 kgs)	<b>\$30</b>
<b>K00425</b>	Replacement LuminIce bulb for Luminice first generation only (bulb with white end caps) Indigos built prior to July 1, 2015	0.5 lbs (0.23 kgs)	<b>\$159</b>
<b>K00454</b>	Replacement LuminIce II bulb for LuminIce II only (bulb with blue end caps) Indigos and Indigo NXT built after July 1, 2015	0.5 lbs (0.23 kgs)	<b>\$159</b>
<b>K00455</b>	Remote Luminice II external LED indicator- for Luminice II and Indigo only	0.5 lbs (0.23 kgs)	<b>\$87</b>
<b>K00528</b>	High intensity Luminice II bulb (Use for larger machines and challenging conditions)	0.5 lbs (0.23 kgs)	<b>\$159</b>
Selected models can be ordered from the factory with the kit already installed. (See model price pages) Other Indigo® NXT models and all Neo® models can have the Luminice II kit added after market. Parts (non "K" kits) must be ordered through distributors.			
<b>LIQUID DESCALER AND SANITIZER FOR CUBER MACHINES</b>			
<b>000005162</b> <b>000005164</b>	Liquid Descaler: 16 oz / .47 liter bottle (sold in cases of 12) Liquid Sanitizer: 16 oz / .47 liter bottle (sold in cases of 12)	16 lbs (7 kgs) 16 lbs (7 kgs)	<b>SEE PARTS</b>
<b>94-0580-3</b> <b>94-0581-3</b>	Liquid Descaler: 1 gallon / 3.78 L (sold in cases of 4) Liquid Sanitizer: 1 gallon / 3.78L (sold in cases of 4)	42 lbs (19 kgs) 42 lbs (19 kgs)	<b>SEE PARTS</b>
<b>LIQUID DESCALER AND SANITIZER FOR SM-50, CONTINUOUS MACHINES (FLAKE, NUGGET, CNF)</b>			
<b>000006036</b>	<b>Liquid Metal-safe Descaler 16 oz / .47 Liter bottle (sold in cases of 12)</b> Hazardous labeling for International Shipments	16 lbs (7 kgs) 16 lbs (7 kgs)	<b>SEE PARTS</b>
<b>000000084</b>	<b>Liquid Metal-safe Descaler 16 oz / .47 Liter bottle (sold in cases of 12)</b> Non-Hazardous labeling for US Shipments only	16 lbs (7 kgs) 16 lbs (7 kgs)	<b>SEE PARTS</b>
<b>000005164</b>	<b>Liquid Sanitizer: 16 oz / .47 Liter bottle (sold in case of 12)</b> Hazardous labeling for International Shipments	16 lbs (7 kgs)	<b>SEE PARTS</b>
<b>POWDER DESCALER AND RINSE FOR CUBER MACHINES AMERICAS MARKETS</b>			
<b>000016265</b> <b>000016278</b>	Powder Descaler: 3 oz / 85 g (sold in cases of 48 packets) E/S/F Powder Rinse: 1.2 oz / 34 g (sold in cases of 48 packets) E/S/F	11 lbs (4 kgs) 6 lbs (3 kgs)	<b>SEE PARTS</b>
<b>000016287</b> <b>000016291</b>	Powder Descaler Starter Kit (Sold in cases of 6 boxes) Powder Rinse Starter kit: (Sold in cases of 6 boxes)	7 lbs (kgs) 5 lbs (2 kgs)	<b>SEE PARTS</b>
Starter kits include: 8 packets, Mixing vessel with lid, instruction sheet. Language: English/Spanish/French			
<b>POWDER DESCALER AND RINSE FOR CUBER MACHINES ASIAN MARKETS</b>			
<b>000016272</b> <b>000016283</b>	Powder Descaler: 3 oz / 85 g (sold in cases of 48 packets) C/K/E Powder Rinse: 1.2 oz / 34 g (sold in cases of 48 packets) C/K/E Hazardous labeling for Air Shipments - Language Chinese/Korean/English	11 lbs (4 kgs) 6 lbs (3 kgs)	<b>SEE PARTS</b>
<b>000016525</b> <b>000016528</b>	Powder Descaler: 3 oz / 85 g (sold in cases of 48 packets) E/C/K Powder Rinse: 1.2 oz / 34 g (sold in cases of 48 packets) E/C/K Hazardous labeling for Air Shipments - Language English/ Chinese/Korean	11 lbs (4 kgs) 6 lbs (3 kgs)	<b>SEE PARTS</b>

ACCESSORIES



Kit	Description	Shipping Weight	Suggested List Price
K00206	6 ea. replacement packets, 1 ea basket, zip ties. For use in Q and S-Series ice machines only. Cannot be used with SF3000C, S3000, Indigo, nugget, flake, or undercounter ice machines.	1 lb (0.5 kg)	\$443



Kit	Description	Shipping Weight	Suggested List Price
AR-Pre-P	Arctic Pure Plus: Pre-filter assembly includes head, shroud, hardware, mounting assembly and one filter cartridge. Use on all machines (Price is for one system, sold in case of 6).	21 lbs (10 kgs)	\$447
AR-10000-P	Arctic Pure Plus: Primary filter assembly includes head, shroud, hardware, mounting assembly and one filter cartridge. See sizing guide. (Price is for one system, sold in case of 6).	25 lbs (11 kgs)	\$619
AR-20000-P	Arctic Pure Plus: Primary filter assembly includes head, shroud, hardware, mounting assembly and one filter cartridge. See sizing guide. (Price is for one system, sold in case of 6).	20 lbs (9 kgs)	\$818
AR-40000-P	Arctic Pure Plus: Primary filter assembly includes head, shroud, hardware, mounting assembly and one filter cartridge. See sizing guide. (Price is for one system, sold in case of 6).	24 lbs (11 kgs)	\$1,022
<b>Arctic Pure PLUS Replacement cartridges sold in cases quantities indicated below:</b>			
K00536	AR-PRE-P replacement cartridge (Price is for case of 6).	14 lbs (6.3 kgs)	\$732
K00537	AR-10000-P replacement cartridge (Price is for case of 10).	20 lbs (9 kgs)	\$2,040
K00538	AR-20000-P replacement cartridge (Price is for case of 6).	17 lbs (7 kgs)	\$1,830
K00495	AR-40000-P replacement cartridge (Price is for case of 12).	27 lbs (12 kgs)	\$5,680



Kit	Description	Shipping Weight	Suggested List Price
<b>Arctic Pure Replacement cartridges sold in cases quantities indicated below:</b>			
K00374001	AR2800 replacement cartridge (Price is for case of 12) Use on SMS50A / UCP50A / USE50A	11 lbs (5 kgs)	\$1,583
K00542	AR-PRE replacement cartridge (Price is for case of 6).	14 lbs (6.3 kgs)	\$732
K00540	AR-10000 replacement cartridge (Price is for case of 10).	20 lbs (9 kgs)	\$2,040
K00541	AR-20000 replacement cartridge (Price is for case of 6).	17 lbs (7 kgs)	\$1,830



Kit	Description	Shipping Weight	Suggested List Price
<b>AR-PRO NEO Replacement cartridges sold in cases quantities indicated below:</b>			
K00530	NEO replacement cartridge 5 micron (Price is for case of 12).	22 lbs (10 kgs)	\$1,680
K00531	NEO replacement cartridge 0.5 micron (Price is for case of 12).	22 lbs (10 kgs)	\$2,415
K00532	NEO replacement cartridge 5 micron international filter (Price is for case of 12).	22 lbs (10 kgs)	\$1,470

Filter Systems (Replacement Cartridges)	AR-PRE (K00337)	AR-10000 (K00338)	AR-20000 (K00339)	AR-40000 (2-K00339)
	AR-PRE-P (K00496)	AR-10000-P (K00493)	AR-20000-P (K00494)	AR-40000-P (K00495)
All Under Counters				
(Cubers, Flakers & Nuggets)	X	X		
Counter Top Nugget				
Modular Cubers: IT0300-IT750, IBF0620				
Modular Flaker: RFP0320	X	X		
Modular Nugget: RNP0320				
Modular Cubers: IT0900, IBF0820C & IBT1020C				
Modular Flaker: RFP0620, RFF1220C, RFF1300	X		X	
Modular Nuggets: RNF0620, RNF1020C, RNF1100				
Modular Cubers: IT1200, IT1500 & IT1900, IF1400C, IT1830C & IF2100C				
Modular Flaker: RFF2200C	X			X
Modular Nugget: RNF2000C				

NOTE: ARCTIC PURE PLUS AND ARCTIC PURE CARTRIDGES ARE NOT COMPATIBLE



Kit	Description	Shipping Weight	Suggested List Price
<b>K00146</b>	Ice bagger assembly, includes bagger, B-Model bin adapter, and 250 bags and ties. Stainless steel finish.	25 lbs (11 kgs)	<b>\$1,158</b>
<b>K00068</b>	Replacement Bags/Ties Bag Kit - Includes 1,000 bags (4 wickets of 250) and ties.	34 lbs (15 kgs)	<b>\$650</b>

CONVENIENT ICE BAGGER



Kit	Description	Shipping Weight	Suggested List Price
<b>3302583</b>	6 oz./.18L clear scoop for QM and SM Series (each)	2 lbs (1 kgs)	<b>See Parts</b>
<b>40002930</b>	22 oz./.65L blue scoop (Used with Neo undercounter units.)	3 lbs (1 kgs)	<b>See Parts</b>
<b>040004889</b>	32 oz./.95L white scoop (each)(Used for B170 and Q-Series undercounter units.)	3 lbs (1 kgs)	<b>See Parts</b>
<b>3302593</b>	82 oz./2.4L white scoop (each)(Used for ice bin D320 and up.)	5 lbs (2 kgs)	<b>See Parts</b>
<b>000015595</b>	5.3 lb / 2.4 kg capacity, NSF approved, blue ABS plastic with knuckle guard, works inside D-Bin or with optional K00461 External Scoop Holder	5.3 lbs (2.4 kgs)	<b>See Parts</b>
<b>K00463</b>	5.3/lbs/2.4kg capacity NSF approved aluminum with knuckle guard. Has limited lifetime guarantee. Works inside D-bins or with optional K00461 External scoop holder	11 lbs /5 kg	<b>\$190</b>

ICE SCOOPS

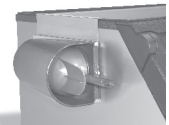

Kit	Description	Shipping Weight	Suggested List Price
<b>K00461</b>	Protects the ice scoop outside the bin. NFS versatile holder can be configured seven ways on the bin or wall. Use with 000015595 scoop that comes with D-Bins, aluminum scoop K00463 (To use K00461 with LB Style bins, you must also purchase the K00482 hanger)	11 lbs (5 kgs)	<b>\$254</b>
<b>K00482</b>	Hanger for F-Style bins to be used with the K00461 External scoop holder	5 lbs (2 kgs)	<b>\$61</b>

EXTERNAL ICE SCOOP HOLDER



Kit	Description	Shipping Weight	Suggested List Price
<b>K00064</b>	2.5" (6.35 cm) Casters. For use with NEO, Q-Series (not QM or UDE), and B170 bin. two (2) ea. locking swivel and two (2) ea. non-locking swivel.	2 lbs (1 kgs)	<b>\$546</b>
<b>K00153</b>	4.625" (11.75 cm) Adjustable Flange Foot - stainless steel (Use with Bins only)	5 lbs (2 kgs)	<b>\$428</b>
<b>K00176</b>	4" (10.16 cm) leg for UDE0065/80 - black painted	3 lbs (1 kgs)	<b>\$229</b>
<b>K00215</b>	UDE Series leveler legs, adjusts from 0.5"-1.25" (1.27-3.175 cm) - 1/2"-13 thread	1 lb / 1 kg	<b>\$112</b>
<b>K00145</b>	6" (15.24 cm) Adjustable Secured Flange Foot - stainless steel (Use with B-Bins only) includes latch bracket #6072421	6 lbs (3 kgs)	<b>\$583</b>
<b>K00144</b>	12" (30.48 cm) Adjustable Flange Foot - stainless steel. Can use with Neo undercounter machines and B170 and B&D 400 Bin. Not for use with 22" (52.9 cm) unit, stacked units, dispensers, or the QM or UDE series.	8 lbs (4 kgs)	<b>\$583</b>
<b>K00138</b>	Adjustable Caster Legs, 7.625-8.625" (19.4 - 21.9 cm) - stainless steel. Not for use with 22" (52.9 cm) unit, or any stacked units, dispensers, QM's, UDE or UFP or UNP. two (2) locking casters and two (2) non-locking per set.	16 lbs (7 kgs)	<b>\$1,196</b>
<b>K00350</b>	6" (15.24 cm) Adjustable Legs - stainless steel standard on B&D Series bins.	5 lbs (2 kgs)	<b>\$204</b>
<b>K00445</b>	1.125" (2.9 cm) Non-adjustable foot. For use with NEO.	2 lbs (1 kgs)	<b>\$113</b>
<b>K00462</b>	Secure fastening kit, includes 6" (15.24cm) adjustable flanged foot, stainless steel with latching hardware. Use with D-Bins and Indigo units only	6 lbs (3 kgs)	<b>\$723</b>

CASTERS / LEGS/ FEET

Parts (non "K" kits ) must be ordered through distributors.



**AHRI CERTIFIED** – Manitowoc Ice Machines and D-Bins are certified by The American Heating and Refrigeration Institute. (AHRI) This means the data we published is validated to be true based on ASHRAE standards. Our certified products are continually tested by an independent third party laboratory to validate our products perform to the ratings or specifications published. Rest assured, products that carry the AHRI label comply to their publish specification. AHRI rates ice machine performance is rated at the 90 ambient temperature and 70 water temperature. Bin capacity rating is measured by the cubic volume of the interior of the bin.



**ENERGY STAR** – Manitowoc Ice is an avid supporter of the EPA's voluntary ENERGY STAR program. We believe in making ENERGY STAR approved ice machines are not only good for the environment but it makes good business sense. In fact, we have more ENERGY STAR models than any other ice machine manufacture. Moreover, Manitowoc Ice is a key contributor to the ENERGY STAR Partner of the Year award winners for 14 consecutive years. Look for the ★ next to the model number to indicate whether a model is ENERGY STAR qualified, then check with your local dealer if it is rebate eligible.



**BEST IN CLASS** – Foodservice Equipment & Supplies (FE&S) magazine conducts an annual survey among its subscribing foodservice operators, dealers, and consultants asking them to evaluate ice machines in the categories of: quality, value, design, service and support, sales and support, inventory and availability. For 17 consecutive years Manitowoc Ice has been voted best in class. Don't take our word for it; take it from the people who know ice machines.

**KITCHEN INNOVATION AWARD 2019** – Indigo NXT, was awarded the 2019 Kitchen Innovation Award from the National Restaurant Association. This prestigious award recognizes Indigo NXT for its innovation, efficiencies and productivity.



**KITCHEN INNOVATION AWARD 2021** – CrystalCraft Premier was awarded the 2021 Kitchen Innovation Award from the National Restaurant Association. This prestigious award recognizes the CrystalCraft Premier for its innovative design and perfectly formed crystal clear square cube.

**KITCHEN INNOVATION AWARD 2025** – NEO was awarded the 2025 Kitchen Innovation Award from the National Restaurant Association. The NEO ice machine was recognized for its integrated water filtration system that ensures the production of ice that is clearer and better tasting, directly at the point of use.



**INTELLIGENT ICE MACHINE** – Manitowoc Indigo NXT with its easyTouch display is the only ice machine that offers a touch display providing the user and service agent with vital information to facilitate the set up and operation of the equipment. The display provides 4 main statuses: Making Ice, Bin Full, Machine Off or Program Mode. All the asset information can be obtained with one touch of an icon. Set up reminders to clean, change the air and water filters can be programmed easily into the machine. You can program the machine NOT to make ice when the store is closed or during the hours of the day of higher energy costs. The self diagnostic feature stores vital information for the service agent to access, so when they arrive, they have a good idea of the problem. This makes servicing easier, reduces labor costs and reduces machine down time.



**EASY TO CLEAN** – Manitowoc Indigo Machines are the easiest ice machines in the industry to clean. All the component parts that require a deep cleaning can be removed without the use of tools. This includes the water trough as well as the water pump. Selected components contain Alpha San- Antimicrobial compound molded into the plastic to reduce slime build up.

**ENERGY EFFICIENT** – Having the most ENERGY STAR models is a result of advance technologies that allow the Indigo NXT ice machine to work efficiently. Innovations like Air Assist which accelerates the ice harvest process and the Acoustical Ice Sensing probe allows for reliable operation in challenging water conditions. Air Assist and Acoustical Ice sensing are patent technologies only found on Manitowoc Indigo machines.



**LUMINICE II VIRUS AND BACTERIA INHIBITOR** – Manitowoc Indigo NXT and Neo machines offer the LuminIce II Virus and Bacteria Inhibitor device that runs quietly 24/7 keeping your ice machine cleaner longer. Less frequent cleanings saves labor, reduces cost and machine downtime. The device is particularly effective in environments where yeast is in the air (sandwich shops, bakeries, pizzerias, micro-breweries) because the LuminIce II device uses a UV bulb to create active air that inhibits the growth of viruses, bacteria, mold and yeast inside the machine. The device is mounted inside the machine, and is integrated with the easy Touch Display with an icon that lets you know the operational status.



**AUTOMATIC CLEANING SYSTEM - (iAUCS)** – Manitowoc Ice automatic cleaning system is a perfect complement to the LuminIce II virus and bacteria inhibitor. Using the easyTouch display on the Indigo NXT Ice machine, program the time interval to either clean or sanitize the food zone automatically. No manual intervention is required. This is especially effective in areas of hard water, where periodic cleaning of the evaporator will keep the evaporator free of lime scale build up. (Note, iAUCS will not eliminate the need to do a deep cleaning periodically) but will keep your machine running at peak efficiency and cleaner longer).



SCAN TO LOCATE A DEALER, DISTRIBUTOR OR  
SALES REPRESENTATIVE IN YOUR AREA



OR VISIT  
[MANITOWOCICE.COM/SALES/SALES-LOCATORS](http://MANITOWOCICE.COM/SALES/SALES-LOCATORS)



  
▶ FROM PENTAIR WATER SOLUTIONS

+1(920)682.0161 FAX +1(920)683.7589  
[manitowocice.com](http://manitowocice.com)

Our customized solutions provide much more than just temporary enhancements. Backed by decades of experience in the industry, our products are relentlessly reliable, built to last and withstand the daily pressures of food service demands. And that's the same dependability reflected in our own strong support network, providing the consistent service you need at every stage of your business.

*Engineered for Ease* • [manitowocice.com](http://manitowocice.com)