



2025 PRICE LIST - AMERICAS

SUGGESTED LIST PRICES
STANDARD EQUIPMENT AND ACCESSORIES

Effective April 15, 2025

ENGINEERED **FOR EASE**

TABLE OF CONTENTS

Cube Ice Machines	3-9	Dispensers	18
Standard Remotes and Top Air Discharge	10	Ice Storage Bins	19-20
QuietQube® Remotes & Ice Beverage.	11-12	International Only.	21
Specialty: Prison and Marine.	13	Bin Adapters & Deflector Kits	22-23
Flake Ice Machines	14-15	Accessories	24-26
Nugget Ice Machines.	16-17		

NOTATIONS

Shipping weights are approximate.
Modular ice machines are not stackable.

TERMS

TERMS

Terms are as Company may extend to purchaser.
Terms for Parts
C.O.D. (Deviation on authorization of Credit Department only.)

PRICES

Prices are Ex-works Manitowoc, Wisconsin.
All prices and specifications are subject to change without notice.

DIMENSION DRAWINGS

Height includes legs set at 6" (15.2 cm).
Legs adjust from 6" – 7.5" (15.2 – 19.1 cm)

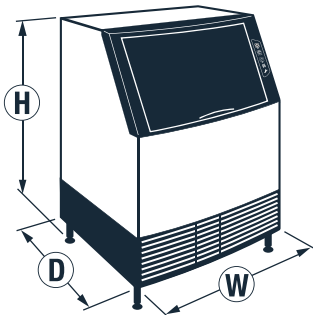

COMMERCIAL WARRANTY

This is a limited warranty. For full terms, visit manitowocice.com/Service/Warranty or call 920-682-0161.

WARRANTY – CUBE ICE MACHINE

- 5-year parts-and-labor coverage on Indigo NXT, S, U, QO and IB-model ice machine evaporators.
- 5-year parts and 3-year labor coverage on Indigo NXT, S, U, QO and IB-model ice machine compressor.
- 3-year parts-and-labor coverage on all dispensers, storage bins, and Indigo NXT, S, U, QO and IB-model ice cube machines.

WARRANTY – UE SERIES ICE MACHINE

- 3-year parts-and-labor coverage on all components.

WARRANTY – UCP AND USP SERIES ICE MACHINES

- 3-year parts-and-labor coverage on all components.

WARRANTY – UFP/RFP, UNP/RNP ICE MACHINES

- 3-year parts.
- 3-year labor.
- Compressor parts for five (5) years and labor for three (3) years.

WARRANTY – COUNTERTOP NUGGET DISPENSER ICE MACHINES (CNP201/202)

- 2-year parts-and-labor coverage on all components.
- Compressor parts for five (5) years and labor for two (2) years.

WARRANTY – RELATED ACCESSORIES

If not stated, kits carry the same basic warranty as the machine they are used on.

RESIDENTIAL WARRANTY

- 1-year parts-and-labor.

ICE STYLES

DICE CUBE:	7/8" x 7/8" x 7/8" 2.22 x 2.22 x 2.22 cm 100% ice to water ratio.
HALF DICE CUBE:	3/8" x 1 1/8" x 7/8" 0.95 x 2.86 x 2.22 cm 100% ice to water ratio.
REGULAR CUBE:	1 1/8" x 1 1/8" x 7/8" 2.86 x 2.86 x 2.22 cm 100% ice to water ratio.
GOURMET CUBE:	1 3/8" x 1 3/8" 3.94 x 3.94 octagon shape cube. 100% ice to water ratio.
NUGGET ICE:	3/8" to 1/2" 0.76 x 0.76 x 1.27 cm pieces. 85% ice to water ratio.
FLAKE ICE:	Flake ice is smaller bits of ice. 73% ice to water ratio.
SQUARE CUBE:	1" square shaped ice. 100% ice to water ratio.
LARGE SQUARE CUBE:	40g, 1.5" x 1.5" x 1.5" square shaped ice. 100% ice to water ratio.

ICE STORAGE CAPACITY

The calculation used to determine actual ice storage capacity varies among manufacturers, most use the AHRI standard. When the AHRI standard is not referenced, use cubic meters capacity for accurate comparison between manufacturer's models.

READING MODEL NUMBERS

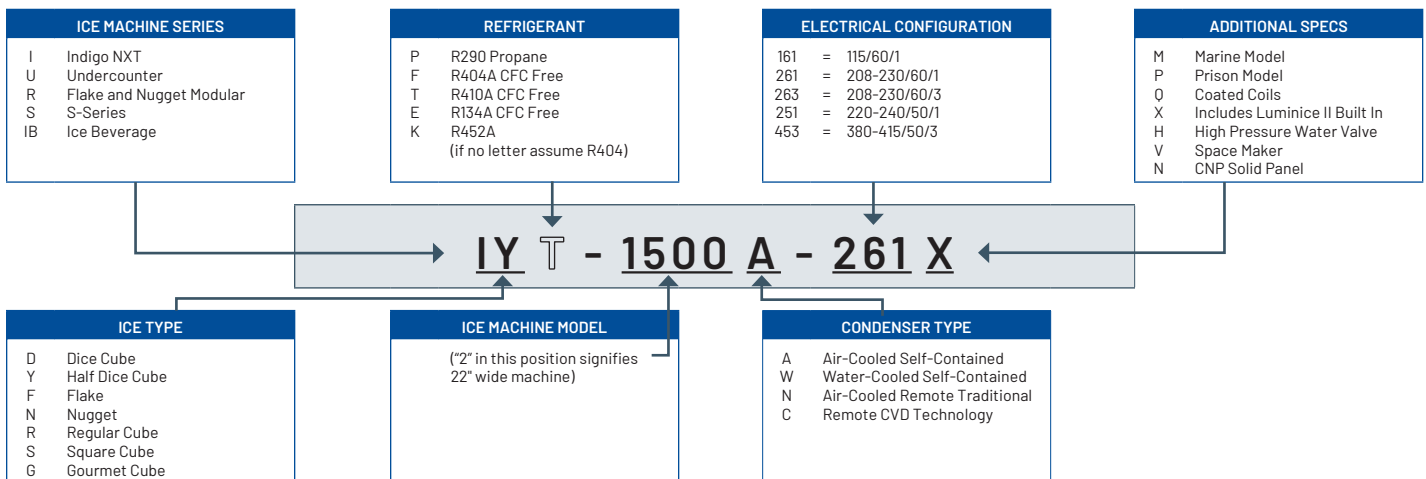

UNDERCOUNTER CUBE

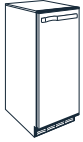

W 14.75" • D 22.75" • H 33.5"
W 37.5 • D 57.8 H • 85.1 cm

53lbs (24 kgs) daily at 70/50°F*
44lbs (20 kgs) daily at 90/70°F*



W 19.69" • D 22.34" • H 36"
W 50.0 D • 56.7 H • 91.4 cm

UDE0065:

57 lbs (26 kgs) daily at 70/50°F*

46 lbs (21 kgs) daily at 90/70°F*

UDE0080:

110 lbs (50 kgs) daily at 70/50

75 lbs (34 kgs) daily at 90/70



W 26" D 28.5" H 38.5"
W 66 D 72.4 H 97.8 cm

UF-140:

*137lbs (62 kgs) daily at 70/50°F

*100lbs (45 kgs) daily at 90/70°F

UF-190:

*193 lbs (88 kgs) daily at 70/50°F

*140lbs (64 kgs) daily at 90/70°F



W 26" D 28.5" H 38.5"
W 66 D 72.4 H 97.8 cm

*219lbs (99 kgs) daily at 70/50°F

*160lbs (73 kgs) daily at 90/70°F

Model	Ice Type	Cooling	Electrical	Shipping Weight	Suggested List Price	Replaces Model
UCP0050A-161	Gourmet	Air	115v/60Hz/1	114 lbs (52 kgs)	\$6,190	SMS050A002-161

Ice storage capacity 25 lbs (11.3 kgs)
Includes 6ft (1.8m) power cord with NEMA 5-15P plug.
Includes AR-2800 water filter.
Drain pump available as accessory (K00376).
Not compatible with iAuCS®.
IMPORTANT NOTE: Use only Metal Safe Cleaner 000000084 on this product. Other cleaners will damage the evaporator and will not be covered under warranty.

Model	Description	Shipping Weight	Suggested List Price
K00376	Drain pump for use when floor drain is not available	7 lbs (kgs)	\$903

Model	Ice Type	Cooling	Electrical	Shipping Weight	Suggested List Price	Replaces Model
UDE0065A-161B	Dice	Air	115v/60Hz/1	109 lbs (49 kgs)	\$5,078	UDE0065A-161B
UDE0080A-161B	Dice	Air	115v/60Hz/1	114 lbs (52 kgs)	\$5,825	UDE0080A-161B
UDE0065A-251Z	Dice	Air	230v/50/Hz/1	109 lbs (49 kgs)	\$5,245	UDE0065A-251Z
UDP0080A-251Z	Dice	Air	230v/50/Hz/1	114 lbs (52 kgs)	\$6,005	UDP0080A-251Z

Ice storage capacity 30lbs (14 kgs)†. Storage capacity is AHRI certified, measured at 1.059 cu ft.
Includes 6 ft (1.8m) power cord with NEMA 5-15P plug.
Price list performance rating is 60hz data.
Refer to individual 50hz spec sheets for 50hz performance rating.
Not compatible with iAuCS or Luminice II.

Model	Ice Type	Cooling	Electrical	Shipping Weight	Suggested List Price	Replaces Model
URF0140A-161B	Regular	Air	115v/60Hz/1	153 lbs (69 kgs)	\$5,999	UR0140A-161B
UDF0140A-161B	Dice	Air	115v/60Hz/1	153 lbs (69 kgs)	\$5,799	UD0140A-161B
UYF0140A-161B	Half Dice	Air	115v/60Hz/1	153 lbs (69 kgs)	\$5,799	UY0140A-161B
UDF0190A-161B	Dice	Air	115v/60Hz/1	153 lbs (69 kgs)	\$5,874	UD0190A-161B
UYF0190A-161B	Half Dice	Air	115v/60Hz/1	153 lbs (69 kgs)	\$5,874	UY0190A-161B
UDP0140A-251Z	Dice	Air	230v/50hz/1	153 lbs (69 kgs)	\$6,036	UD0140A-251Z
UYF0140A-251Z	Half Dice	Air	230v/50hz/1	153 lbs (69 kgs)	\$6,036	UY0140A-251Z
UDF0190A-251Z	Dice	Air	230v/50hz/1	153 lbs (69 kgs)	\$6,245	UD0190A-251Z
UYF0190A-251Z	Half Dice	Air	230v/50hz/1	153 lbs (69 kgs)	\$6,245	UY0190A-251Z

Cubic Volume 3.037. Storage capacity is AHRI certified. Cubic Volume 3.037.
Application storage capacity† 90 lbs (40 kgs)
Includes 6 ft (1.8m) power cord with NEMA 5-15P plug ("B" Plug).
Price list performance rating is 60hz data. Refer to individual 50hz spec sheets for 50hz performance rating.
Not compatible with iAuCS. Luminice® II compatible as accessory.

Model	Ice Type	Cooling	Electrical	Shipping Weight	Suggested List Price	Replaces Model
UDF0240A-161B	Dice	Air	115v/60Hz/1	157 lbs (72kgs)	\$6,893	UD0240A-161B
UDF0240A-261Z	Dice	Air	208-230v/60hz/1	157 lbs (72kgs)	\$6,968	UD0240A-261Z
UDF0240W-161B	Dice	Water	115v/60Hz/1	160 lbs (73 kgs)	\$7,450	UD0240W-161B
UYF0240A-161B	Half Dice	Air	115v/60Hz/1	159 lbs (72 kgs)	\$6,893	UY0240A-161B
UYF0240W-161B	Half Dice	Water	115v/60Hz/1	159 lbs (72 kgs)	\$7,450	UY0240W-161B
UDP0240A-251Z	Dice	Air	230v/50hz/1	157 lbs (72kgs)	\$7,162	UD0240A-251Z
UYF0240A-251Z	Half Dice	Air	230v/50hz/1	159 lbs (72 kgs)	\$7,162	UY0240A-251Z
UYF0240W-251Z	Half Dice	Water	230v/50hz/1	159 lbs (72 kgs)	\$7,516	UY0240W-251Z

Cubic Volume 3.037. Storage Capacity is AHRI certified.
Application storage capacity† 90 lbs (40 kgs)
Includes 6 ft (1.8 m) power cord with NEMA 5-15P plug ("B" Plug).
Price list performance rating is 60hz data. Refer to individual 50hz spec sheets for 50hz performance rating.
Not compatible with iAuCS. Luminice II compatible as accessory.

* Daily ice production based on half dice air-cooled condenser model at air temperature/water temperature.
† Application storage capacity measured 90% of total volume in cubic feet. x 33 lbs / ft³

UNDERCOUNTER CUBE (continued)

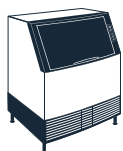

W 30" • D 28.5" • H 38.5"
W 76.2 • D 72.4 • H 97.8 cm

290lbs (132 kgs) daily at 70/50°F*
235 lbs (107 kgs) daily at 90/70°F*

Model	Ice Type	Cooling	Electrical	Shipping Weight	Suggested List Price	Replaces Model
URF0310A-161B	Regular	Air	115v/60Hz/1	208 lbs (94 kgs)	\$8,591	UR0310A-161B
UDF0310A-161B	Dice	Air	115v/60Hz/1	208 lbs (94 kgs)	\$8,391	UD0310A-161B
UDF0310A-261Z	Dice	Air	208-230v/60hz/1	208 lbs (94 kgs)	\$8,466	UD0310A-261Z
UDF0310W-161B	Dice	Water	115v/60Hz/1	211 lbs (96 kgs)	\$9,069	UD0310W-161B
UYF0310A-161B	Half Dice	Air	115v/60Hz/1	209 lbs (95 kgs)	\$8,391	UY0310A-161B
UYF0310W-161B	Half Dice	Water	115v/60Hz/1	211 lbs (96 kgs)	\$9,069	UY0310W-161B
URF0310A-251Z	Regular	Air	230v/50hz/1	208 lbs (94 kgs)	\$8,924	UR0310A-251Z
UDP0310A-251Z	Dice	Air	230v/50hz/1	208 lbs (94 kgs)	\$8,703	UD0310A-251Z
UYF0310A-251Z	Half Dice	Air	230v/50hz/1	209 lbs (95 kgs)	\$8,703	UY0310A-251Z

Application ice storage capacity[†] 119 lbs/54 kg. Cubic Volume 3.99. Storage Capacity is AHRI Certified. Includes 6"/1.8 m power cord with NEMA 5-15P plug ("B" Plug). Price list performance rating is 60hz data. Refer to individual 50hz spec sheets for 50hz performance rating. Not compatible with iAuCS. LuminIce® II compatible as accessory.

SQUARE CUBE



W 19.68" • D 22.83" • H 37.5"
100 lbs (45.5 kgs) at 70/50*
85 lbs (38.5 kgs) at 90/70*

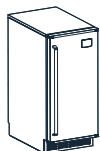

W 14.75" • D 22.75" • H 33.5"
W 37.5 • D 57.8 • H 85.1 cm
45 lbs (20 kgs) at 70/50*
35 lbs (15 kgs) at 90/70*

Model	Ice Type	Cooling	Electrical	Shipping Weight	Suggested List Price	Replaces Model
USP0100A-161	Square	Air	115v/60Hz/1	209 lbs (95 kgs)	\$6,487	N/A

Application storage capacity[†] 38 lbs/17.2 kgs. Measured volume is two (2) cubic feet. Storage Capacity is AHRI certified. Includes 6 ft (1.8m) power cord with NEMA 5-15 plug. Refer to Install Use and Care manual for proper cleaning instructions. Not compatible with iAuCS or LuminIce II.

Model	Ice Type	Cooling	Electrical	Shipping Weight	Suggested List Price	Replaces Model
USE0050A-161	Square	Air	115v/60Hz/1	121 lbs (54.4 kgs)	\$8,325	N/A

Ice storage capacity 25 lbs / 11.3 kg. Includes 6 ft (1.8m) power cord with NEMA 5-15P plug. Includes AR-2800 water filter. Not compatible with iAuCS or LuminIce. Use only metal safe cleaner 00000084.

Model	Description	Shipping Weight	Suggested List Price
K00516	Drain pump for use when floor drain is not available	7 lbs (kgs)	\$903
K00517	Left door hinge kit	20 lbs (9 kgs)	\$967

MODULAR CUBE

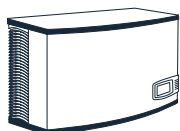

W 30" • D 24.5" • H 16.50"
W 76.2 • D 62.2 • H 41.9 cm

310 lbs (141 kgs) daily at 70/50°F*
230 lbs (104 kgs) daily at 90/70°F*



Model	Ice Type	Cooling	Electrical	Shipping Weight	Suggested List Price	Replaces Model
IDT0300A-161★	Dice	Air	115v/60Hz/1	142 lbs (64 kgs)	\$7,844	IDF0300A-161
IDT0300A-161X	Dice	Air	115v/60Hz/1	147 lbs (67 kgs)	\$8,734	IDF0300A-161X
IDT0300A-261★	Dice	Air	115v/60Hz/1	142 lbs (64 kgs)	\$7,919	IDF0300A-261
IDT0300W-161	Dice	Water	115v/60Hz/1	139 lbs (63 kgs)	\$8,730	IDF0300W-161
IYT0300A-161★	Half Dice	Air	115v/60Hz/1	147 lbs (67 kgs)	\$7,844	IYF0300A-161
IYT0300A-161X	Half Dice	Air	115v/60Hz/1	152 lbs (69 kgs)	\$8,734	IYF0300A-161X
IYT0300A-261★	Half Dice	Air	208-230/60Hz/1	147 lbs (67 kgs)	\$7,919	IYF0300A-261
IYT0300W-161	Half Dice	Water	115v/60Hz/1	144 lbs (65 kgs)	\$8,730	IYF0300W-161
IYT0300W-161X	Half Dice	Water	115v/60Hz/1	149 lbs (68 kgs)	\$9,620	IYF0300W-161X
IDT0300A-251	Dice	Air	230v/50Hz/1	142 lbs (64 kgs)	\$8,380	IDF0300A-251

If factory installed LuminIce II not offered, use aftermarket kit found on page 24. **RECOMMENDED BINS:** D400 or D570 (See page 19) See pages 22-23 for required adapters, deflectors, and dispenser baffles. Price list performance rating is 60hz data. Refer to individual 50hz spec sheets for 50hz performance rating.

★ ENERGY STAR® Qualified Model | Air filter standard on self-contained air-cooled ice cube machines.
* Daily ice production based on half dice air-cooled condenser model at air temperature/water temperature.
† Application storage capacity measured 90% of total volume in cubic feet. x 33 lbs / ft³

MODULAR CUBE (continued)

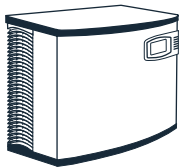

W 22" • D 24.5" • H 21.5"
W 55.9 • D 62.2 • H 54.6 cm

460 lbs (209 kgs) daily at 70/50°F*
375 lbs (170 kgs) daily at 90/70°F*

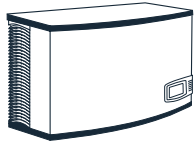

W 30" • D 24.5" • H 21.5"
W 76.2 • D 62.2 • H 54.6 cm

490 lbs (222 kgs) daily at 70/50°F*
378 lbs (171 kgs) daily at 90/70°F*

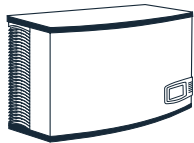

W 30" • D 24.5" • H 21.5"
W 76.2 • D 62.2 • H 54.6 cm

550 lbs (249 kgs) daily at 70/50°F*
440 lbs (200 kgs) daily at 90/70°F*



IT0420 SERIES

Model	Ice Type	Cooling	Electrical	Shipping Weight	Suggested List Price	Replaces Model
IDT0420A-161★	Dice	Air	115v/60Hz/1	137 lbs (62 kgs)	\$8,654	ID0322A-161
IDT0420A-161X	Dice	Air	115v/60Hz/1	142 lbs (64 kgs)	\$9,544	ID0322A-161X
IDT0420A-261	Dice	Air	230v/60Hz/1	137 lbs (62kgs)	\$8,729	ID0322A-261
IDT0420W-161	Dice	Water	115v/60Hz/1	131 lbs (59 kgs)	\$9,360	ID0323W-161
IYT0420A-161★	Half Dice	Air	115v/60Hz/1	136 lbs (62 kgs)	\$8,654	IY0324A-161
IYT0420A-161X	Half Dice	Air	115v/60Hz/1	141 lbs (64 kgs)	\$9,544	IY0324A-161X
IYT0420W-161	Half Dice	Water	115v/60Hz/1	135 lbs (61 kgs)	\$9,360	IY0325W-161
IDT0420A-251	Dice	Air	230v/50hz/1	137 lbs (62 kgs)	\$8,891	ID0322A-251
IYT0420A-251	Half Dice	Air	230v/50Hz/1	136 lbs (62 kgs)	\$8,891	IY0324A-251

If factory installed LuminIce II not offered, use aftermarket kit found on page 24.
Recommended Bins: D320 or D420 (see page 19-20). See pages 22-23 for required adapters, deflectors, and dispenser baffles.
 Price list performance rating is 60hz data. Refer to individual 50hz spec sheets for 50hz performance rating.

IT0450 SERIES

Model	Ice Type	Cooling	Electrical	Shipping Weight	Suggested List Price	Replaces Model
IDT0450A-161★	Dice	Air	115v/60Hz/1	160 lbs (73 kgs)	\$8,477	ID0452A-161
IDT0450A-161X	Dice	Air	115v/60Hz/1	165 lbs /75 kg	\$9,367	ID0452A-161X
IDT0450W-161	Dice	Water	115v/60Hz/1	141 lbs (64 kgs)	\$9,167	ID0453W-161
IDT0450W-161X	Dice	Water	115v/60Hz/1	146 lbs (66 kgs)	\$10,057	ID0453W-161X
IYT0450A-161★	Half Dice	Air	115v/60Hz/1	170 lbs (77 kgs)	\$8,477	IY0454A-161
IYT0450A-161X	Half Dice	Air	115v/60Hz/1	175 lbs (79 kgs)	\$9,367	IY0454A-161X
IYT0450W-161	Half Dice	Water	115v/60Hz/1	155 lbs (70 kgs)	\$9,167	IY0455W-161
IYT0450W-161X	Half Dice	Water	115v/60Hz/1	160 lbs (73 kgs)	\$10,057	IY0455W-161X
IDT0450A-251	Dice	Air	230v/50hz/1	160 lbs (73 kgs)	\$8,796	ID0452A-251
IDT0450W-251	Dice	Water	230v/50hz/1	141 lbs (64 kgs)	\$9,233	ID0453W-251
IYT0450A-251	Half Dice	Air	230v/50hz/1	170 lbs (77 kgs)	\$8,796	IY0454A-251

If factory installed LuminIce II not offered, use aftermarket kit found on page 24.
Recommended Bins: D400 or D570 (see page 19-20). See pages 22-23 for required adapters, deflectors, and dispenser baffles.
 Price list performance rating is 60hz data. Refer to individual 50hz spec sheets for 50hz performance rating.

IT0500 / IF0500N SERIES

Model	Ice Type	Cooling	Electrical	Shipping Weight	Suggested List Price	Replaces Model
IRT0500A-161★	Regular	Air	115v/60Hz/1	162 lbs (73 kgs)	\$9,820	IR0500A-161
IRT0500A-261★	Regular	Air	208-230v/60Hz/1	162 lbs (73 kgs)	\$9,895	IR0500A-261
IRT0500W-161	Regular	Water	115v/60Hz/1	158 lbs (72 kgs)	\$10,502	IR0501W-161
IDT0500A-161★	Dice	Air	115v/60Hz/1	157 lbs (72kgs)	\$9,570	ID0502A-161
IDT0500A-161X	Dice	Air	115v/60Hz/1	162 lbs (73 kgs)	\$10,460	ID0502A-161X
IDT0500A-261★	Dice	Air	208-230v/60hz/1	157 lbs (72kgs)	\$9,645	ID0502A-261
IDT0500W-161	Dice	Water	115v/60Hz/1	163 lbs (74 kgs)	\$10,252	ID0503W-161
IDF0500N-161A	Dice	Remote	115v/60Hz/1	164 lbs (74 kgs)	\$9,349	IDT0500N-161
IDF0500N-161AX	Dice	Remote	115v/60Hz/1	169 lbs (77 kgs)	\$10,239	IDT0500N-161X
IYT0500A-161★	Half Dice	Air	115v/60Hz/1	159 lbs (72 kgs)	\$9,570	IY0504A-161
IYT0500A-161X	Half Dice	Air	115v/60Hz/1	164 lbs (74 kgs)	\$10,460	IY0504A-161X
IYT0500A-261	Half Dice	Air	208-230v/60Hz/1	159 lbs (72 kgs)	\$9,645	IY0504A-261
IYT0500W-161	Half Dice	Water	115v/60Hz/1	161 lbs (73 kgs)	\$10,252	IY0505W-161
IYF0500N-161A	Half Dice	Remote	115v/60Hz/1	161 lbs (73 kgs)	\$9,349	IYT0500N-161
IYF0500N-161AX	Half Dice	Remote	115v/60Hz/1	166 lbs (75 kgs)	\$10,239	IYT0500N-161X
IDT0500A-251	Dice	Air	230v/50hz/1	157 lbs (72kgs)	\$9,734	ID0502A-251

If factory installed LuminIce II not offered, use aftermarket kit found on page 24.
Recommended Bins: D400 or D570 (see page 19-20). See pages 22-23 for required adapters, deflectors, and dispenser baffles.
 Price list performance rating is 60hz data. Refer to individual 50hz spec sheets for 50hz performance rating.

★ ENERGY STAR® Qualified Model | Air filter standard on self-contained air-cooled ice cube machines.
 * Daily ice production based on half dice air-cooled condenser model at air temperature/water temperature.
 † Application storage capacity measured 90% of total volume in cubic feet. x 33 lbs / ft³

MODULAR CUBE (continued)

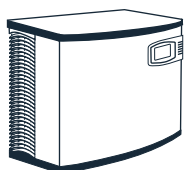

W 22" • D 24.5" • H 21.5"
W 55.9 • D 62.2 • H 54.6 cm

575 lbs (262 kgs) daily at 70/50 °F*
465 lbs (211 kgs) daily at 90/70 °F*



Model	Ice Type	Cooling	Electrical	Shipping Weight	Suggested List Price	Replaces Model
IRT0620A-161★	Regular	Air	115v/60Hz/1	143 lbs (65 kgs)	\$ 9,493	IR0520A-161
IDT0620A-161★	Dice	Air	115v/60Hz/1	143 lbs (65 kgs)	\$ 9,243	ID0522A-161
IDT0620A-161X	Dice	Air	115v/60Hz/1	148 lbs (67 kgs)	\$ 10,133	ID0522A-161X
IDT0620A-261★	Dice	Air	208-230v/60Hz/1	143 lbs (65 kgs)	\$ 9,318	ID0522A-261
IDT0620W-161	Dice	Water	115v/60Hz/1	140 lbs (63 kgs)	\$ 9,903	ID0523W-161
IYT0620A-161★	Half Dice	Air	115v/60Hz/1	145 lbs (66 kgs)	\$ 9,243	IY0524A-161
IYT0620A-161X	Half Dice	Air	115v/60Hz/1	150 lbs (68 kgs)	\$ 10,133	IY0524A-161X
IYT0620A-261★	Half Dice	Air	208-230v/60Hz/1	145 lbs (66 kgs)	\$ 9,318	IY0524A-261
IYT0620W-161	Half Dice	Water	115v/60Hz/1	140 lbs (63 kgs)	\$ 9,903	IY0525W-161
IYT0620W-261	Half Dice	Water	208-230v/60Hz/1	140 lbs (63 kgs)	\$ 9,978	IY0525W-261
IRT0620A-251	Regular	Air	230v/50Hz/1	143 lbs (65 kgs)	\$ 9,672	IR0520A-251
IRT0620W-251	Regular	Water	230v/50Hz/1	140 lbs (63 kgs)	\$ 10,151	IR0521W-251
IDT0620A-251	Dice	Air	230v/50Hz/1	140 lbs (63 kgs)	\$ 9,404	ID0522A-251
IDT0620W-251	Dice	Water	230v/50Hz/1	140 lbs (63 kgs)	\$ 9,870	ID0523W-251
IYT0620A-251	Half Dice	Air	230v/50Hz/1	145 lbs (66 kgs)	\$ 9,404	IY0524A-251
IYT0620W-251	Half Dice	Water	230v/50Hz/1	140 lbs (63 kgs)	\$ 9,870	IY0525W-251

If factory installed LuminIce II not offered, use aftermarket kit found on page 24.

Recommended Bins: D320 or D420 (see page 19-20).

See pages 22-23 for required adapters, deflectors, and dispenser baffles.

Price list performance rating is 60Hz data. Refer to individual 50Hz spec sheets for 50Hz performance rating.

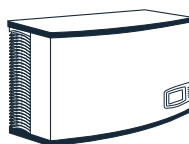

W 30" • D 24.5" • H 29.5"
W 76.2 • D 62.2 H • 74.9 cm

715 lbs (325 kgs) daily at 70/50
575 lbs (261 kgs) daily at 90/70



Model	Ice Type	Cooling	Electrical	Shipping Weight	Suggested List Price	Replaces Model
IDT0750A-261★	Dice	Air	208-230v/60Hz/1	194 lbs (88 kgs)	\$10,755	IDF0600A-261
IDT0750W-261	Dice	Water	208-230v/60Hz/1	194 lbs (88 kgs)	\$11,532	IDF0600W-261
IDT0750N-261★	Dice	Remote	208-230v/60Hz/1	214 lbs (97 kgs)	\$10,142	IDF0600N-261A
IYT0750A-261★	Half Dice	Air	208-230v/60Hz/1	208 lbs (94 kgs)	\$10,755	IYF0600A-261
IYT0750A-261X	Half Dice	Air	208-230v/60Hz/1	213 lbs (97 kgs)	\$11,645	IYF0600A-261X
IYT0750W-261	Half Dice	Water	208-230v/60Hz/1	195 lbs (88 kgs)	\$11,532	IYF0600W-261
IYT0750N-261★	Half Dice	Remote	208-230v/60Hz/1	221 lbs (100 kgs)	\$10,142	IYF0600N-261A
IYT0750N-261X★	Half Dice	Remote	208-230v/60Hz/1	226 lbs (103 kgs)	\$11,032	IYF0600N-261AX
IDT0750A-251	Dice	Air	230v/50Hz/1	194 lbs (88 kgs)	\$11,046	IDF0600A-251
IYT0750A-251	Half Dice	Air	230v/50Hz/1	208 lbs (94 kgs)	\$11,046	IYF0600A-251
IYT0750A-251X	Half Dice	Air	230v/50Hz/1	213 lbs (97 kgs)	\$11,936	IYF0600A-251X
IYT0750W-251	Half Dice	Water	230v/50Hz/1	195 lbs (88 kgs)	\$11,598	IYF0600W-251
IYT0750N-251	Half Dice	Remote	230v/50Hz/1;	221 lbs (100kgs)	\$10,357	IYF0600N-251A

If factory installed LuminIce II not offered, use aftermarket kit found on page 24.

Recommended Bins: D570, D970 or LB730 (see page 19-20).

See pages 22-23 for required adapters, deflectors, and dispenser baffles.

Use JCT1,200 remote condenser and RT(JR-410A tubing kit (see page 10).

Kit K00347 ice deflector must be ordered separately if used with: non-Manitowoc bins, Manitowoc LB-Style bins.

Price list performance rating is 60Hz data. Refer to individual 50Hz spec sheets for 50Hz performance rating.

★ ENERGY STAR® Qualified Model | Air filter standard on self-contained air-cooled ice cube machines.

* Daily ice production based on half dice air-cooled condenser model at air temperature/water temperature.

† Application storage capacity measured 90% of total volume in cubic feet. x 33 lbs / ft³

MODULAR CUBE (continued)

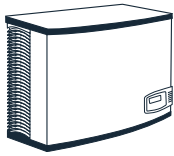

W 30" • D 24.5" • H 26.5"
W 76.2 • D 62.2 • H 67.3 cm

830 lbs (376 kgs) daily at 70/50°F*
740 lbs (336 kgs) daily at 90/70°F*

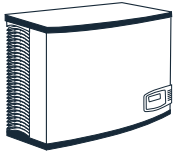

W 30" • D 24.5" • H 26.5"
W 76.2 • D 62.2 • H 67.3 cm

865 lbs (392 kgs) daily at 70/50°F*
750 lbs (340 kgs) daily at 90/70°F*



Model	Ice Type	Cooling	Electrical	Shipping Weight	Suggested List Price	Replaces Model
-------	----------	---------	------------	-----------------	----------------------	----------------

IF0900 SERIES

IYF0900A-263A	Half Dice	Air	208-230v/60Hz/3	219 lbs (99 kgs)	\$14,829	IYF0900A-263
---------------	-----------	-----	-----------------	------------------	----------	--------------



If factory installed LuminIce II not offered, use aftermarket kit found on page 24.
Recommended Bins: D570, D970 and LB0730 (See page 19-20).
See pages 22-23 for required adapters, deflectors, and dispenser baffles.
Use JCF0900 remote condenser and RT()R-404A tubing kit (see page 10).
Kit K00347 ice deflector must be ordered separately if used with: non-Manitowoc bins, Manitowoc LB-Style bins. Price list performance rating is 60hz data. Refer to individual 50hz spec sheets for 50hz performance rating.

Mode	Ice Type	Cooling	Electrical	Shipping Weight	Suggested List Price	Replaces Model
------	----------	---------	------------	-----------------	----------------------	----------------

IT0900 SERIES

IRT0900A-261	Regular	Air	208-230v/60Hz/1	213 lbs (97 kgs)	\$14,704	IRF0900A-261
IRT0900W-261	Regular	Water	208-230v/60Hz/1	232 lbs (105 kgs)	\$15,771	IRF0900W-261
IDT0900A-261★	Dice	Air	208-230v/60Hz/1	214 lbs (97 kgs)	\$14,404	IDF0900A-261
IDT0900A-261X	Dice	Air	208-230v/60Hz/1	219 lbs (99 kgs)	\$15,294	IDF0900A-261X
IDT0900W-261	Dice	Water	208-230v/60Hz/1	212 lbs (96 kgs)	\$15,431	IDF0900W-261
IDT0900N-261★	Dice	Remote	208-230v/60Hz/1	221 lbs (100 kgs)	\$14,467	IDF0900N-261A
IYT0900A-261★	Half Dice	Air	208-230v/60Hz/1	218 lbs (99 kgs)	\$14,404	IYF0900A-261
IYT0900A-261X	Half Dice	Air	208-230v/60Hz/1	223 lbs (101 kgs)	\$15,294	IYF0900A-261X
IYT0900W-261	Half Dice	Water	208-230v/60Hz/1	218 lbs (99 kgs)	\$15,431	IYF0900W-261
IYT0900N-261★	Half Dice	Remote	208-230v/60Hz/1	218 lbs (99 kgs)	\$14,467	IYF0900N-261A
IRT0900A-251	Regular	Air	230v/50Hz/1	213 lbs (97 kgs)	\$15,116	IRF0900A-251
IRT0900W-251	Regular	Water	230v/50Hz/1	212 lbs (96 kgs)	\$15,871	IRF0900W-251
IDT0900A-251	Dice	Air	230v/50Hz/1	214 lbs (97 kgs)	\$14,795	IDF0900A-251
IDT0900N-251	Dice	Remote	230v/50/Hz/1	221 lbs (100 kgs)	\$14,432	IDF0900N-251A
IYT0900A-251	Half Dice	Air	230v/50Hz/1	218 lbs (99 kgs)	\$14,795	IYF0900A-251
IYT0900N-251	Half Dice	Remote	230v/50/Hz/1	218 lbs (99 kgs)	\$14,432	IYF0900N-251A

If factory installed LuminIce II not offered, use aftermarket kit found on page 24.
Recommended Bins: D570, D970 or LB0730, LB0730, LB0730, LB0730, LB0730, LB0730 (see page 19-20).
See pages 22-23 for required adapters, deflectors, and dispenser baffles.
Use JCT1200 remote condenser and RT()R-410A tubing kit (see page 10).
Kit K00347 ice deflector must be ordered separately if used with: non-Manitowoc bins, Manitowoc LB-Style bins.
Price list performance rating is 60hz data. Refer to individual 50hz spec sheets for 50hz performance rating.

★ ENERGY STAR® Qualified Model | Air filter standard on self-contained air-cooled ice cube machines.

* Daily ice production based on half dice air-cooled condenser model at air temperature/water temperature.



MODULAR CUBE (continued)

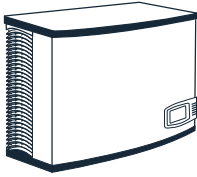

W 30" • D 24.5" • H 29.5 in
W 76.2 • D 62.2 • H 74.9 cm

1213 lbs /550 kg daily at 70/50°F*
950 lbs /431 kg daily at 90/70°F*

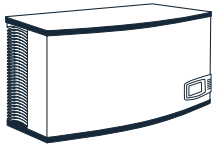
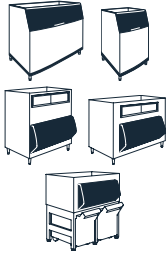

W 48" • D 24.5" • H 29.5"
W 121.9 • D 62.2 • H 74.9 cm

1660 lbs (753 kga) at 70/50°F*
1412 lbs (640 kgs) at 90/70°F*

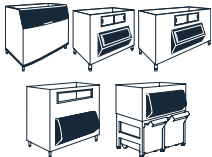

Model	Ice Type	Cooling	Electrical	Shipping Weight	Suggested List Price	Replaces Model
IDT1200A-261	Dice	Air	208-230v/60hz/1	232 lbs (105 kgs)	\$16,292	ID1106A-261
IDT1200W-261	Dice	Water	208-230v/60hz/1	228 lbs (103 kgs)	\$17,444	ID1106W-261
IDT1200N-261	Dice	Remote	208-230v/60hz/1	228 lbs (103 kgs)	\$16,083	IDT1200N-261
IYT1200A-261	Half Dice	Air	208-230v/60hz/1	241 lbs (109 kgs)	\$16,292	IY1106A-261
IYT1200A-261X	Half Dice	Air	208-230v/60hz/1	246 lbs (112 kgs)	\$17,182	IY1106A-261X
IYT1200A-263	Half Dice	Air	208-230v/60hz/3	241 lbs (109 kgs)	\$16,592	IYT1200A-263
IYT1200W-261	Half Dice	Water	208-230v/60hz/1	238 lbs (108 kgs)	\$17,444	IY1106W-261
IYT1200W-263	Half Dice	Water	208-230v/60hz/3	238 lbs (108 kgs)	\$17,744	IYT1200W-263
IYT1200N-261	Half Dice	Remote	208-230v/60hz/1	236 lbs (107 kgs)	\$16,083	IYT1200N-261
IYT1200N-263	Half Dice	Remote	208-230v/60hz/3	236 lbs (107 kgs)	\$16,383	IY1196N3-263
IDT1200A-251	Dice	Air	230v/50hz/1	232 lbs (105 kgs)	\$16,862	ID1106A-251
IDT1200W-251	Dice	Water	230v/50hz/1	228 lbs (103 kgs)	\$17,444	ID1106W-251
IYT1200A-251	Half Dice	Air	230v/50hz/1	241 lbs (109 kgs)	\$16,862	IY1106A-251
IYT1200W-251	Half Dice	Water	230v/50hz/1	238 lbs (108 kgs)	\$17,691	IY1106W-251
IYT1200N-251	Half Dice	Remote	230v/50hz/1	236 lbs (107 kgs)	\$16,648	IYT1200N-251

IT1200 SERIES

If factory installed LuminIce II not ordered, use aftermarket kit found on page 24.
Recommended Bins: D970, D570, LB1448, LB1460, LBCS1360 (see page 19-20)
 See pages 22-23 for required adapters, deflectors, and dispenser baffles.
 Use JCT1200 remote condenser and RT(JR-410A tubing kit (see page 10).
 Kit K00347 ice deflector must be ordered separately if used with: non-Manitowoc bins, Manitowoc LB-Style bins.
 Price list performance rating is 60hz data. Refer to individual 50hz spec sheets for 50hz performance rating.

Model	Ice Type	Cooling	Electrical	Shipping Weight	Suggested List Price	Replaces Model
IDT1500A-261A	Dice	Air	208-230v/60hz/1	292 lbs (132 kgs)	\$ 19,060	IDT1500A-261
IDT1500A-263E	Dice	Air	208-230v/60hz/3	292 lbs (132 kgs)	\$ 19,410	IDT1500A-263
IDT1500W-261A	Dice	Water	208-230v/60hz/1	298 lbs (135 kgs)	\$ 20,217	IDT1500W-261
IDT1500W-263E	Dice	Water	208-230v/60hz/3	298 lbs (135 kgs)	\$ 20,567	IDT1500W-263
IDT1500N-261E★	Dice	Remote	208-230v/60hz/1	293 lbs (133 kgs)	\$ 18,822	IDT1500N-261A
IYT1500A-261A	Half Dice	Air	208-230v/60hz/1	292 lbs (132 kgs)	\$ 19,060	IYT1500A-261
IYT1500A-261AX	Half Dice	Air	208-230v/60hz/1	297 lbs (135 kgs)	\$ 19,950	IYT1500A-261X
IYT1500A-263E★	Half Dice	Air	208-230v/60hz/3	292 lbs (132 kgs)	\$ 19,410	IYT1500A-263
IYT1500W-261A	Half Dice	Water	208-230v/60hz/1	294 lbs (133 kgs)	\$ 20,217	IYT1500W-261
IYT1500N-261E★	Half Dice	Remote	208-230v/60hz/1	298 lbs (135 kgs)	\$ 18,822	IYT1500N-261A
IYT1500N-261EX	Half Dice	Remote	208-230v/60hz/1	303 lbs (137 kgs)	\$ 19,712	IYT1500N-261X
IYT1500N-263E★	Half Dice	Remote	208-230v/60hz/3	298 lbs (135 kgs)	\$ 19,172	IYT1500N-263
IDT1500A-251A	Dice	Air	230v/50hz/1	292 lbs (132 kgs)	\$ 19,502	IDT1500A-251
IDT1500W-251A	Dice	Water	230v/50hz/1	292 lbs (132 kgs)	\$ 20,465	IDT1500W-251
IYT1500A-251A	Half Dice	Air	230v/50hz/1	292 lbs (132 kgs)	\$ 19,502	IYT1500A-251
IYT1500W-251A	Half Dice	Water	230v/50hz/1	294 lbs (133 kgs)	\$ 20,465	IYT1500W-251
IYT1500N-251E	Half Dice	Remote	230v/50hz/1	298 lbs (135 kgs)	\$ 19,262	IYT1500N-251

IT1500 SERIES

If factory installed LuminIce II not offered, use aftermarket kit found on page 24.
Recommended Bins: D970, LB1448, LB1460, LB1760, LBCS1360+S (See page 19-20s).
 See pages 22-23 for required adapters and deflectors.
 Use JCT1500 remote condenser and RL(JR-410A tubing kit (see page 10).
 Kit K0034900 ice deflector must be ordered separately if used with: non-Manitowoc bins, Manitowoc LB-Style bins.
 Price list performance rating is 60hz data. Refer to individual 50hz spec sheets for 50hz performance rating.

★ ENERGY STAR® Qualified Model | Air filter standard on self-contained air-cooled ice cube machines.
 * Daily ice production based on half dice air-cooled condenser model at air temperature/water temperature.

MODULAR CUBE (continued)

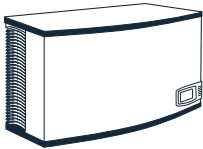

W 48" • D 24.5" • H 29.5"
 W 121.9 • D 62.2 • H 74.9 cm
 1965 lbs (891 kgs) at 70/50°F*
 1535 lbs (696 kgs) at 90/70°F*

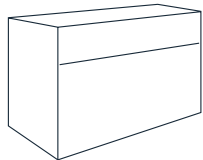
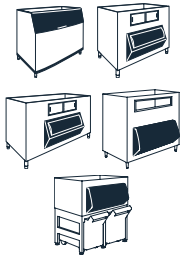

W 48" • D 31 in H 36"
 W 121.9 • D 78.7 • H 91.4 cm
 3200 lbs (1451 kgs) daily
 at 70/50°F*
 2584 lbs (1172 kgs) daily at
 90/70°F*

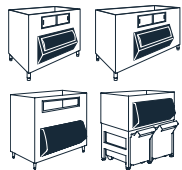

IT1900 SERIES

Model	Ice Type	Cooling	Electrical	Shipping Weight	Suggested List Price	Replaces Model
IRT1900A-261E	Regular	Air	208-230v/60hz/1	317 lbs (144 kgs)	\$22,709	IRT1900A-261
IRT1900A-263E	Regular	Air	208-230v/60hz/3	317 lbs (144 kgs)	\$23,059	IRT1900A-263
IRT1900N-261E	Regular	Remote	208-230v/60hz/1	324 lbs (147 kgs)	\$22,506	IRT1900N-261A
IRT1900N-263E	Regular	Remote	208-230v/60hz/3	324 lbs (147 kgs)	\$22,856	IRT1900N-263
IRT1900N-263EX	Regular	Remote	208-230v/60hz/3	324 lbs (147 kgs)	\$23,746	IRT1900N-263X
IDT1900A-263E	Dice	Air	208-230v/60hz/3	317 lbs (144 kgs)	\$22,759	IDT1900A-263
IDT1900W-261E	Dice	Water	208-230v/60hz/1	319 lbs (145 kgs)	\$23,994	IDT1900W-261A
IDT1900W-263E	Dice	Water	208-230v/60hz/3	319 lbs (145 kgs)	\$24,344	IDT1900W-263
IDT1900N-261E★	Dice	Remote	208-230v/60hz/1	324 lbs (147 kgs)	\$22,206	IDT1900N-261A
IDT1900N-263E★	Dice	Remote	208-230v/60hz/3	324 lbs (147 kgs)	\$22,556	IDT1900N-263
IYT1900A-261E	Half Dice	Air	208-230v/60hz/1	321 lbs (146 kgs)	\$22,409	IYT1900A-261
IYT1900A-263E	Half Dice	Air	208-230v/60hz/3	321 lbs (146 kgs)	\$22,759	IYT1900A-263
IYT1900W-261E	Half Dice	Water	208-230v/60hz/1	322 lbs (146 kgs)	\$23,994	IYT1900W-261A
IYT1900W-263E	Half Dice	Water	208-230v/60hz/3	322 lbs (146 kgs)	\$24,344	IYT1900W-263
IYT1900N-261E★	Half Dice	Remote	208-230v/60hz/1	330 lbs (150 kgs)	\$22,206	IYT1900N-261A
IYT1900N-261EX	Half Dice	Remote	208-230v/60hz/1	335 lbs (152 kgs)	\$23,096	IYT1900N-261X
IYT1900N-263E★	Half Dice	Remote	208-230v/60hz/3	330 lbs (150 kgs)	\$22,556	IYT1900N-263
IYT1900N-263EX	Half Dice	Remote	208-230v/60hz/3	335 lbs (152 kgs)	\$23,446	IYT1900N-263X
IRT1900A-251E	Regular	Air	230v/50hz/1	317 lbs (144 kgs)	\$23,430	IRT1900A-251
IDT1900A-251E	Dice	Air	230v/50hz/1	317 lbs (144 kgs)	\$23,099	IDT1900A-251
IDT1900N-251E	Dice	Remote	230v/50hz/1	324 lbs (147 kgs)	\$22,891	IDT1900N-251
IYT1900A-251E	Half Dice	Air	230v/50hz/1	324 lbs (146 kgs)	\$23,099	IYT1900A-251

If factory installed LuminIce II not offered, use aftermarket kit found on page 24.
Recommended Bins: D970, LB1448, LB1460, LB1760, LBCS1360+S (See page 20).
 See pages 22-23 for required adapters and deflectors.
 *Use JCT1500 remote condenser and RL(JR-410A tubing kit (see page 10).
 Kit K0034900 ice deflector must be ordered separately if used with: non-Manitowoc bins, Manitowoc LB-Style bins.
 Price list performance rating is 60hz data. Refer to individual 50hz spec sheets for 50hz performance rating.

S-3000 SERIES

Model	Ice Type	Cooling	Electrical	Shipping Weight	Suggested List Price	Replaces Model
SDT3000W-263H	Dice	Water	208-230v/60hz/31	501 lbs (227 kgs)	\$40,429	SD3303W3-263HP
SYT3000W-263H	Half Dice	Water	208-230v/60hz/3	516 lbs (234 kgs)	\$40,429	SY3305W3-263HP

Recommended Bins: LB1448, LB1460, LB1760, LBCS130+S (See page 20).
 See pages 22-23 for required adapters and deflectors.
 Not for use with iAuCS cleaning system or LuminIce II.
 K00391 and K00396 Needed for the LB1448. Requires adapter that does not come with the bin.
 KLB604800 with the LB1460 and LB1760 and the KLB614800 for the LBCS1360.
 H = High pressure valve regulates from 20 psi to 350 psi or 137.9 kPa to 2413.2 kPa.

★ ENERGY STAR® Qualified Model | Air filter standard on self-contained air-cooled ice cube machines.
 * Daily ice production based on half dice air-cooled condenser model at air temperature/water temperature.

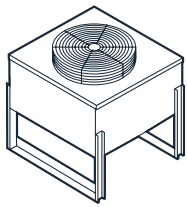

STANDARD REMOTE AIR-COOLED CONDENSER

Model	For Use with Remote Ice Machine	Electrical	Shipping Weight	Suggested List Price	Replaces Model
JCF0500-161	iF0500N	115v/60hz/1	64 lbs (29 kgs)	\$2,707	JC0495-161
JCF0500-161Q	iF0500N	115v/60hz/1	65 lbs (29 kgs)	\$3,007	JC0495-161Q
JCF0900-261	iF900N	208-230v/60hz/1	78 lbs (35 kgs)	\$3,053	JC 0895 and 0995-261
JCF0900-261Q	iF900N	208-230v/60hz/1	79 lbs (36 kgs)	\$3,353	JC0995-261Q
JCT1200-261	iT0750N, iT0900N and iT1200N	208-230v/60hz/1	78 lbs (35 kgs)	\$3,244	JC0995-261
JCT1200-261Q	iT0750N, iT0900N and iT1200N	208-230v/60hz/1	79 lbs (36 kgs)	\$3,544	N/A
JCT1500-261	iT1500N and iT1900N	208-230v/60hz/1	80 lbs (36 kgs)	\$3,533	JC1395-261
JCT1500-261Q	iT1500N and iT1900N	208-230v/60hz/1	81 lbs (37 kgs)	\$3,833	JC1395-261Q
JCT1200-251	iT1900N and iT1200N	230v/50hz/1	78 lbs (35 kgs)	\$3,524	JC0995-251
JCT1500-251	iT1500N and iT1900N	230v/50hz/1	80 lbs (36 kgs)	\$3,816	JC1395-251

NOTE: Models with Q suffix are available with coated coils that provide extra corrosion protection in salt spray environments. Coated Coil models require longer lead time, please contact the factory.



STANDARD REMOTE TUBING KITS & ACCESSORIES

Kit	For Use with Series	Tubing Length	Shipping Weight	Suggested List Price
RT20R404	iF0500, iF600 and iF900 Precharged with quick connects	20ft (6.1m)	10 lbs (5 kgs)	\$650
RT35R404	iF0500, iF600 and iF900 Precharged with quick connects	35ft (10.7m)	15 lbs (7 kgs)	\$800
RT50R404	iF0500, iF600 and iF900 Precharged with quick connects	50ft (15.2m)	22 lbs (10 kgs)	\$962
RT20R410A	iT0750N, iT0900N and iT1200 Precharged with quick connects	20ft (6.1m)	10 lbs (5 kgs)	\$669
RT35R410A	iT0750N, iT0900N and iT1200 Precharged with quick connects	35ft (10.7m)	15 lbs (7 kgs)	\$825
RT50R410A	iT0750N, iT0900N and iT1200 Precharged with quick connects	50ft (15.2m)	22 lbs (10 kgs)	\$991
RL20R410A	iT1500 and iT1900 Precharged with quick connects	20ft (6.1m)	10 lbs (5 kgs)	\$669
RL35R410A	iT1500 and iT1900 Precharged with quick connects	35ft (10.7m)	15 lbs (7 kgs)	\$825
RL50R410A	iT1500 and iT1900 Precharged with quick connects	50ft (15.2m)	22 lbs (10 kgs)	\$991

Accessory

K00129	Remote Coupling Kit needed for non-Manitowoc Tubing		2 lbs (1 kgs)	\$226
--------	---	--	---------------	-------

NOTE: Manitowoc remote systems are only approved and warranted as a complete new package. Replacing an ice machine with an Indigo NXT, RNF or RNS model requires a NEW condenser and line set. Use of a new multi-circuited condenser is approved when sized and installed as outlined in Manitowoc Product Information. Rack system applications are not approved.

Top Air Discharge Kits

K00379	Indigo NXT iT0450, iT0500, iF0600, iT0750		18 lbs (9 kgs)	\$719
K00438	Indigo NXT iT0420 and iT0620 models		17 lbs (8 kgs)	\$719
K00439	Indigo NXT iF0900 and iT0900		17 lbs (8 kgs)	\$719
K00449	Indigo NXT iT1200		18 lbs (9 kgs)	\$719
K00481B	Indigo NXT iT1500 and iT1900 models		29 lbs (13 kgs)	\$719

NOTE: Top air discharge kits are used when there is not sufficient clearance on the sides of an air cooled machine. These kits change the side panels and top panel so the air intake is from the back of the machine and the exhaust is re-routed out of the top of the machine rather than the sides.

QUIETCUBE ICE MACHINES

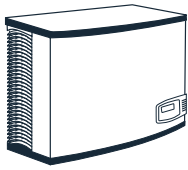

IF0600C
W 30" • D 24.5" • H 21.5"
W 76.2 • D 62.2 • H 54.6 cm

IF0900C
W 30" • D 24.5" • H 26.5"
W 76.2 • D 62.2 • H 67.3 cm

IT1200C
W 30" • D 24.5" • H 29.5"
W 76.2 • D 62.2 • H 74.9 cm

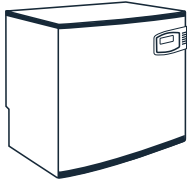

IF1400C
W 30" • D 24.5" • H 25"
W 76.2 • D 62.2 • H 63.5 cm

IT1830C/IF2100C
W 30" • D 24.5" • H 29.5"
W 76.2 • D 62.2 • H 74.9 cm

K00526 is required when installing these ice machines on top of a Cornelius ProGate IDC255 Dispenser.

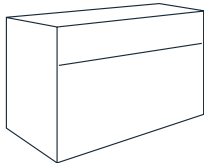

SF3000C
W 48" • D 31" • H 36"
W 121.9 • D 78.7 • H 91.4 cm

ICE / BEV ICE MACHINES

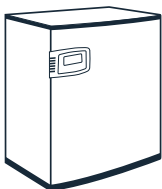

IBF0620
W 22" • D 14" • H 24"
W 55.9 • D 35.6 • H 61.0 cm

IBF0820
W 22" • D 14" • H 26.5"
W 55.9 • D 35.6 • H 67.3 cm

IBT1020C
W 22" • D 14" • H 30.5"
W 55.9 • D 35.6 • H 77.5 cm

QUIETCUBE AND ICE BEVERAGE MACHINES

Model	Ice Type	Cooling	Electrical	Shipping Weight	Suggested List Price	Replaces Model
IDT1200C-161	Dice	Remote	115v/60Hz/1	171 lbs (78 kgs)	\$ 14,953	ID1176C-161
IDF1400C-161	Dice	Remote	115v/60Hz/1	174 lbs (79 kgs)	\$ 16,534	IDT1430C-161
IDF1800C-161	Dice	Remote	115v/60Hz/1	210 lbs (95 kgs)	\$ 20,929	ID1872C-161
IDT1830C-161★	Dice	Remote	115v/60Hz/1	210 lbs (95 kgs)	\$ 20,929	IDF1800C-161
IDF2100C-161	Dice	Remote	115v/60Hz/1	210 lbs (95 kgs)	\$ 24,738	ID2176C-161
IYF0600C-161★	Half Dice	Remote	115v/60Hz/1	146 lbs (66 kgs)	\$ 10,861	IY0686C-161
IYF0900C-161★	Half Dice	Remote	115v/60Hz/1	161 lbs (73 kgs)	\$ 13,744	IY0976C-161
IYF0900C-161X	Half Dice	Remote	115v/60Hz/1	166 lbs (75 kgs)	\$ 14,634	IY0976C-161X
IYT1200C-161	Half Dice	Remote	115v/60Hz/1	174 lbs (79 kgs)	\$ 14,953	IY1176C-161
IYF1400C-161	Half Dice	Remote	115v/60Hz/1	179 lbs (81 kgs)	\$ 16,534	IYT1430C-161
IYF1400C-161X	Half Dice	Remote	115v/60Hz/1	184 lbs / 83 kg	\$ 17,424	IYT1430C-161X
IYF1800C-161	Half Dice	Remote	115v/60Hz/1	210 lbs (95 kgs)	\$ 20,929	IY1874C-161
IYF1800C-161 X	Half Dice	Remote	115v/60Hz/1	215 lbs (98 kgs)	\$ 21,819	IY1874C-161X
IYT1830C-161★	Half Dice	Remote	115v/60Hz/1	210 lbs (95 kgs)	\$ 20,929	IYF1800C-161
IYT1830C-161X★	Half Dice	Remote	115v/60Hz/1	215 lbs (98 kgs)	\$ 21,819	IYF1800C-161X
IYF2100C-161	Half Dice	Remote	115v/60Hz/1	210 lbs (95 kgs)	\$ 24,738	IY2176C-161
IYF2100C-161X	Half Dice	Remote	115v/60Hz/1	210 lbs (95 kgs)	\$ 25,628	IY2176-161X
SYF3000C-161	Half Dice	Remote	115v/60Hz/1	423 lbs (192 kgs)	\$ 36,594	SY3074C-161
IBF0620C-161	Half Dice	Remote	115v/60Hz/1	122 lbs (55 kgs)	\$ 12,330	IB0696YC-161
IBF0820C-161★	Half Dice	Remote	115v/60Hz/1	130 lbs (59 kgs)	\$ 14,709	IB0894YC-161
IBT1020C-161	Half Dice	Remote	115v/60Hz/1	148 lbs (67 kgs)	\$ 16,000	IB1094YC-161
IYF0600C-251	Half Dice	Remote	230v/50hz/1	146 lbs (66 kgs)	\$ 11,141	IY0686C-251
IYF01800C-251	Half Dice	Remote	230v/50hz/1	210 lbs (95 kgs)	\$ 21,589	IY1874C-251
IBT1020C-251	Half Dice	Remote	230v/50hz/1	148 lbs (67 kgs)	\$ 16,563	IBF0820C-251

If factory installed LuminIce II not offered, use aftermarket kit found on page 24.
Price list performance rating is 60hz data. Refer to individual 50hz spec sheets for 50hz performance rating.

QUIETCUBE AND ICE BEVERAGE MACHINES

Daily Ice Production

MODEL	70/50°F	90/70°F	MODEL	70/50°F	90/70°F
IDT1200C	1,130 lbs (513 kgs)	930 lbs / 422 kg	IYF1400C	1,425 lbs (646 kgs)	1,230 lbs / 558 kg
IDF1400C	1,350 lbs (612 kgs)	1,120 lbs / 508 kg	IYT1830C	1,874 lbs (850 kgs)	1,560 lbs / 708 kg
IDT1830C	1,771 lbs (803 kgs)	1,500 lbs / 680 kg	IYF2100C	1,800 lbs (816 kgs)	1,600 lbs / 726 kg
IDF2100C	1,800 lbs (816 kgs)	1,575 lbs / 714 kg	SYF3000C	2,910 lbs (1,320 kgs)	2,400 lbs / 1,089 kg
IYF0600C	600 lbs (272 kgs)	530 lbs / 240 kg	IBF0620C	675 lbs (306 kgs)	564 lbs / 256 kg
IYF0900C	816 lbs (370 kgs)	675 lbs (306 kgs)	IBF0820C	825 lbs (374 kgs)	728 lbs / 330 kg
IYT1200C	1,155 lbs (525 kgs)	955 lbs / 433 kg	IBT1020C	1,206 lbs (547 kgs)	1,030 lbs / 467 kg

Ice deflectors required for single machines on LB-style bins.
Two machines side by side require unique deflectors and adapters. (See page 22 for reference.)

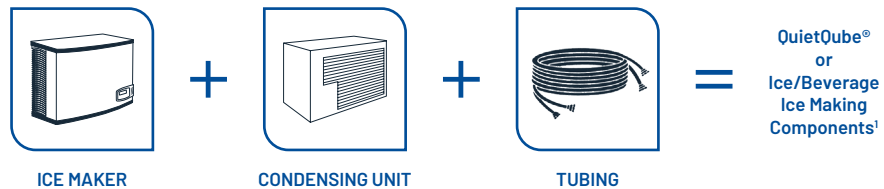

NOTE: Manitowoc remote systems are only approved and warranted as a complete new package. Replacing an ice machine with an Indigo remote model requires a NEW condenser and line set. Only Manitowoc CVD condensing units are approved with QQ and IB Series machines.

*Appropriate adapter is required with ice dispensers or storage bin. For Quiet Cube machines other than IB machines, an optional K00477 bin dispenser thermostat kit may be required for high humidity locations to reduce equipment sweating. IB ice machines come equipped from the factory with a built in bin dispenser thermostat.

★ ENERGY STAR® Qualified Model | Air filter standard on self-contained air-cooled ice cube machines.
* Daily ice production based on half dice air-cooled condenser model at air temperature/water temperature.

CONDENSING UNITS

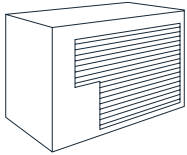

CVDF0600, CVDF0900,
CVDT1200, CVDF1400,
CVDF1800, RCU1000,
RCUF1200, RCUF2200
W 34" • D 24.13" • H 25.75"
W 86.4 • D 61.3 • H 65.4cm

RJC1275

W 45.5" • D 16.5" • H 31"
W 115.6 • D 42 • H 78.5 cm

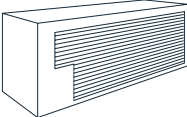

CVDF2100/CVDF3000
W 53" • D 26" • H 25.75"
W 134.6 • D 66 • H 65.4 cm

RJC2375

W 51.4 • D 18.5" • H 45.7"
W 130.6 • D 47 • H 116 cm

CONDENSING UNITS

Model	Cooling	Use With	Electrical	Shipping Weight	Suggested List Price	Replaces Model
CVDF0600-261A	Air	IF0600C, IBF0620C	208-230v/60hz/1	178 lbs (81 kgs)	\$4,652	CVDF0600-261
CVDF0600-263A	Air	IF0600C, IBF0620C	208-230v/60hz/3	178 lbs (81 kgs)	\$4,952	CVDF0600-263
CVDF0900-261A	Air	IF0900C, IBF0820C	208-230v/60hz/1	183 lbs (83 kgs)	\$5,268	CVDF0900-261
CVDF0900-263A	Air	IF0900C, IBF0820C	208-230v/60hz/3	183 lbs (83 kgs)	\$5,568	CVDF0900-263
CVDT1200-261	Air	IT1200C, IBT1020C	208-230v/60hz/1	208 lbs (94 kgs)	\$5,708	CVDT1200-261
CVDT1200-263	Air	IT1200C, IBT1020C	208-230v/60hz/3	208 lbs (94 kgs)	\$6,008	CVDT1200-261
CVDT1200-263Q	Air	IT1200C, IBT1020C	208-230v/60hz/3	208 lbs (94 kgs)	\$6,308	CVDT1200-263Q
CVDF1400-261A	Air	IF1400C	208-230v/60hz/1	190 lbs (86 kgs)	\$6,409	CVDT1400-261
CVDF1400-261AQ	Air	IF1400C	208-230v/60hz/1	190 lbs (86 kgs)	\$6,709	CVDT1400-261Q
CVDF1400-263A	Air	IF1400C	208-230v/60hz/3	190 lbs (86 kgs)	\$6,709	CVDT1400-263
CVDT1800-261	Air	IT1830C	208-230v/60hz/1	195 lbs (88 kgs)	\$7,349	CVDF1800-261A
CVDT1800-263	Air	IT1830C	208-230v/60hz/3	195 lbs (88 kgs)	\$7,699	CVDF1800-263A
CVDT1800-261Q	Air	IT1830C	208-230v/60hz/1	195 lbs (88 kgs)	\$7,649	CVDF1800-261
CVDT1800-263Q	Air	IT1830C	208-230v/60hz/3	195 lbs (88 kgs)	\$7,999	CVDF1800-263Q
CVDF2100-261	Air	IF2100C	208-230v/60hz/1	266 lbs (121 kgs)	\$8,166	ICVD2096-261
CVDF2100-263	Air	IF2100C	208-230v/60hz/3	266 lbs (121 kgs)	\$8,516	ICVD2096-263
CVDF3000-263	Air	sF3000C	208-230v/60hz/3	268 lbs (122 kgs)	\$12,334	CVD30853-263
RCUF1200-261	Air	RFF1220C	208-230v/60hz/1	201 lbs (91 kgs)	\$5,212	RCUF1200-261
RCUF1000-261A	Air	RNF1020C	208-230v/60hz/1	201 lbs (91 kgs)	\$5,111	RCUF1000-261
RCUF2200-263	Air	RFF2200C, RNF2000C	208-230v/60hz/3	249 lbs (113 kgs)	\$6,465	RCU23753-263
CVDF0600-251A	Air	IF0600C	230v/50hz/1	178 lbs (81 kgs)	\$4,764	CVDF0600-251
CVDT1200-251	Air	IBT1200C	230v/50hz/1	208 lbs (94 kgs)	\$6,012	N/A
CVDF1800-251A	Air	IF1800C	230v/50hz/1	195 lbs (88 kgs)	\$7,669	ICVD1895-251
RJC1275-453	Air	RFS1278C	380-415/50hz/3	315 lbs (143 kgs)	\$9,893	N/A
RJC2375-453	Air	RFS2378C	380-415/50hz/3	315 lbs (143 kgs)	\$13,917	N/A

NOTE: Models with "Q" suffix are available with coated coils that provide extra corrosion protection in salt spray environments

QUIETQUBE® • IB REMOTE TUBING KITS • ACCESSORIES

KIT	Indigo NXT, Flake Nugget Remote Tubing kits	Shipping Weight	Suggested List Price
RC31	30 ft (9.1m) tubing length for CVD0600, CDV0900, CVD1200, CVDT1400, RCUF and RJC condensing units. Not Precharged	17 lbs (8 kgs)	\$648
RC51	50 ft (15.2m) tubing length for CVD0600, CVD0900, CVD1200, CVDT1400, RCUF and RJC condensing units. Not Precharged	27 lbs (12 kgs)	\$1,094
RC30	30 ft (9.1m) tubing length for CVDF1400, and CVDT1800. Not Precharged	20 lbs (9 kgs)	\$743
RC50	50 ft (15.2m) tubing length for CVDF1400, and CVDT1800. Not Precharged	31 lbs (14 kgs)	\$1,177
RC33	30 ft (9.1m) tubing length for CVD2100. Not Precharged	25 lbs (11 kgs)	\$1,083
RC53	50 ft (15.2m) tubing length for the CVD2100. Not Precharged	39 lbs (18 kgs)	\$1,780
K00166	S-Trap kit for CVDF1400, 1800, 2100 and CVD3000 condensing units with line set rise over 20 ft / 6.1 m		\$120
K00172	S-trap kit for Indigo NXT series CVD0600, 0900, 12000 and CVDT1400 condensing units with line set rise over 20 ft / 6.1 m		\$2,221
SF3000C Tubing Kits			
RC34	30 ft (9.1m) Tubing length for CVD3000	47 lbs (21 kgs)	\$1,373
RC54	50 ft (15.2 m) Tubing length for CVD3000	73 lbs (33 kgs)	\$2,221
IB ADAPTER FOR CORNELIUS DISPENSER: Ordered and shipped from Manitowoc Ice			
K00340	For 22 in (55.9 cm) wide Enduro 150 for McDonald's ABS unit	27 lbs (12 kgs)	\$1,566
K00341	24.5 in (62.2 cm) Enduro 175 kit no longer available (use Cornelius 629007571)	—	
K00342	30 in (76.2 cm) Enduro 200 (250)	31 lbs (14 kgs)	\$1,944
K00343	44 in (111.8 cm) Enduro 300	47 lbs (21 kgs)	\$2,321
IB Accessory			
K00436	IBT1020C Back Enclosure Kit (for IB1094YC and IBT1020C only) Hides electrical and water lines for pleasing appearance.	12 lbs (5 kgs)	\$385

SPECIALTY MODELS

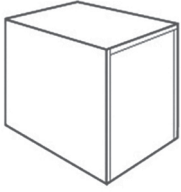

W 34" • D 24.13" • H 25.75"
W 86.4 • D 61.3 • H 65.4cm

RJC1275

W 45.5" • D 16.5" • H 31"
W 115.6 • D 42 H • 78.5 cm

PRISON	Model	Ice Type	Cooling	Electrical	Shipping Weight	Suggested List Price	Replaces Model
	IDT0450A-161P	Dice	Air	115v/60Hz/1	160 lbs (73 kgs)	\$9,577	ID0452A-161P
	IDT0750A-261P	Dice	Air	208-230v/60hz/1	194 lbs (88 kgs)	\$11,855	IDF0600A-261P
	IDT1200A-261P	Dice	Air	208-230v/60hz/1	232 lbs (105 kgs)	\$17,392	ID1106A-261P
	DT1500A-261AP	Dice	Air	208-230v/60hz/1	292 lbs (132 kgs)	\$20,160	IDT1500A-261P

NOTE: For dimensions and performance see base model
Prison models require more lead time than normal, please contact the factory.
LuminIce II is available as an after-market kit. Please see page 24.

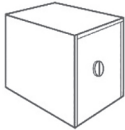
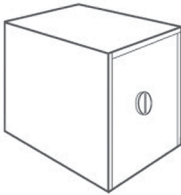

MARINE	Model	Ice Type	Cooling	Electrical	Shipping Weight	Suggested List Price	Replaces Model
	IDT0750W-261M	Dice	Water	208-230v/60hz/1	194 lbs (88 kgs)	\$16,082	IDF0600W-261M
	IDT0900W-261M	Dice	Water	208-230v/60hz/1	212 lbs (96 kgs)	\$20,765	IDF0900W-261M
	IDT1900W-261EM	Dice	Water	208-230v/60hz/1	334 lbs (151 kgs)	\$28,499	IDT1900W-261AM
	IYT0900W-261M	Half Dice	Water	208-230v/60hz/1	218 lbs (99 kgs)	\$20,765	IYF0900W-261M
	IYT1900W-261EM	Half Dice	Water	208-230v/60hz/1	337 lbs (153 kgs)	\$28,499	IYT1900W-261AM
	IYT1900W-263EM	Half Dice	Water	208-230v/60hz/3	337 lbs (153 kgs)	\$28,849	IYT1900W-263M

NOTE: For dimensions and performance see base model
Marine models require more lead time than normal, please check with the factory.

IDT0900W-261V	Dice	Water	208-230v/60hz/1	212 lbs (96 kgs)	\$21,699	IDF0900W-261V
IYT0900W-261V	Half Dice	Water	208-230v/60hz/1	218 lbs (99 kgs)	\$21,699	IYF0900W-261V
IDT1900W-261EV	Dice	Water	208-230v/60hz/1	334 lbs / 151kg	\$29,355	IDT1900W-261V
IYT1900W-261EV	Half Dice	Water	208-230v/60hz/1	337 lbs / 153kg	\$29,355	IYT1900W-261V

NOTE: For dimensions and performance see base model
Marine models require more lead time than normal, please check with the factory.

★ ENERGY STAR® Qualified Model | Air filter standard on self-contained air-cooled ice cube machines.

* Daily ice production based on half dice air-cooled condenser model at air temperature/water temperature.



UNDERCOUNTER FLAKE



W 19.7" • D 26" • H 37.5"
W 50.0 • D 66.0 • H 95.3 cm

272 lbs (123 kgs) daily at 70/50°F*
201 lbs (91 kgs) daily at 90/70°F*



W 29" • D 27" • H 39.5"
W 73.8 • D 69.0 • H 100.4 cm

400 lbs (181 kgs) at 70/50°F
321 lbs (145 kgs) at 90/70°F

Model	Ice Type	Cooling	Electrical	Shipping Weight	Suggested List Price	Replaces Model
UFP0200A-161★	Flake	Air	115v/60hz/1	168 lbs (76 kgs)	\$11,052	UFF0200A-161
UFK0200AZ-251	Flake	Air	230v/50hz/1	168 lbs (76 kgs)	\$11,226	RF0266AZ-251

Application Storage Capacity[†]: 50 lbs / 23 kg. Cubic volume 1.7. Storage capacity is AHRI certified.
Includes 6 ft / 1.8 m power cord with NEMA 5-15P plug.
Use cleaner (000000084) only with this model.
Not compatible with iAuCS® or LuminIce II.
Price list performance rating is 60hz data.
50 Hz Electric Connection: Add Z for Bare Lead cord.

Model	Ice Type	Cooling	Electrical	Shipping Weight	Suggested List Price	Replaces Model
UFP0350A-161★	Flake	Air	115v/60hz/1	224 lbs (102 kgs)	\$11,496	UFF0350A-161
UFK0350AZ-251	Flake	Air	230v/50hz/1	224 lbs (102 kgs)	\$11,674	RF0385AZ-251

Application Storage Capacity[†]: 60 lbs/27 kg. Measured cubic volume 2.04 Storage Capacity is AHRI certified
Includes 6 ft / 1.8 m power cord with NEMA 5-15P plug.
Use cleaner (000000084) only with this model.
Not compatible with iAuCS or LuminIce II.
Price list performance rating is 60hz data.
50 Hz Electric Connection: Add Z for Bare Lead cord.

MODULAR FLAKE

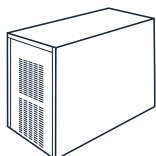

W 22" • D 23.6" • H 26"
W 55.9 • D 59.9 • H 66.0 cm

365 lbs (165 kgs) daily at 70/50°F*
287 lbs (130 kgs) daily at 90/70°F*

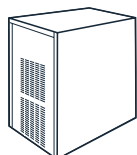

W 22" • D 23.6" • H 26 in
W 55.9 • D 59.9 • H 66.0 cm

*682 lbs (309 kgs) daily at 70/50°F
*527 lbs (239 kgs) daily at 90/70°F

Model	Ice Type	Cooling	Electrical	Shipping Weight	Suggested List Price	Replaces Model
RFP0320A-161★	Flake	Air	115v/60hz/1	174 lbs (79 kgs)	\$10,009	RFF0320A-161
RFK0320AZ-251	Flake	Air	230v/50hz/1	174 lbs (79 kgs)	\$10,172	RFS0300AZ-251

Recommended Bins: D320 or D420 (See page 19-20).
See pages 22-23 for required adapters.
Use cleaner (000000084) only with this model.
Price list performance rating is 60hz data.
Not compatible with SPA/SFA dispensers, iAuCS, or LuminIce II.
50 Hz Electric Connection: Add Z for Bare Lead cord.

Model	Ice Type	Cooling	Electrical	Shipping Weight	Suggested List Price	Replaces Model
RFP0620A-161	Flake	Air	115v/60hz/1	230 lbs (104 kgs)	\$12,419	RFF0620A-161
RFP0620W-161	Flake	Water	115v/60hz/1	230 lbs (104 kgs)	\$13,167	RFF0620W-161
RFK0620AZ-251	Flake	Air	230v/50hz/1	230 lbs (104 kgs)	\$12,607	RFS0650AZ-251
RFK0620WZ-251	Flake	Water	230v/50hz/1	230 lbs (104 kgs)	\$13,233	RFS0650WZ-251

Recommended Bins: D320 or D420 (See page 19-20).
See pages 22-23 for required adapters.
Use cleaner (000000084) only with this model.
Price list performance rating is 60hz data.
Not compatible with SPA/SFA dispensers, iAuCS, or LuminIce II.
50 Hz Electric Connection: Add Z for Bare Lead cord.

★ ENERGY STAR® Qualified Model | Air filter standard on self-contained air-cooled ice cube machines.

* Daily ice production based on half dice air-cooled condenser model at air temperature/water temperature.

† Application storage capacity measured 90% of total volume in cubic feet. x 33 lbs / ft³

MODULAR FLAKE

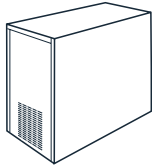

W 30" • D 23.6" • H 27.4"
W 76.2 • D 59.9 • H 70.0 cm

1264 lbs (573 kgs) daily at 70/50°F*
951 lbs (431 kgs) daily at 90/70°F*

RFF1300

Model	Ice Type	Cooling	Electrical	Shipping Weight	Suggested List Price	Replaces Model
RFF1300A-261	Flake	Air	208-230v/60hz/1	263 lbs (119 kgs)	\$18,337	RFS1200A-261
RFF1300W-261	Flake	Water	208-230v/60hz/1	263 lbs (119 kgs)	\$19,443	RFS1200W-261
RFK1300AZ-251	Flake	Air	230v/50hz/1	263 lbs (119 kgs)	\$18,765	RFS1200AZ-251
RFK1300WZ-251	Flake	Water	230v/50hz/1	263 lbs (119 kgs)	\$19,691	RFS1200WZ-251



Recommended Bins: D570, D970 (See page 19-20)
See pages 22-23 for required adapters.
Use cleaner (000000084) only with this model.
Price list performance rating is 60hz data.
Not compatible with SPA/SFA dispensers, iAuCS, or LuminIce® II
50 Hz Electric Connection: Add Z for Bare Lead cord.

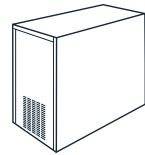

W 22" • D 23.6" • H 26"
W 55.9 • D 59.9 • H 66.0 cm

1092 lbs (495 kgs) daily at 70/50°F*
958 lbs (435 kgs) daily at 90/70°F*

RFF1220

Model	Ice Type	Cooling	Electrical	Shipping Weight	Suggested List Price	Replaces Model
RFF1220C-261	Flake	Remote	208-230v/60hz/1	186 lbs (84 kgs)	\$15,855	RFS1278C-261
RFS1278C-251	Flake	Remote	230v/50hz/1	186 lbs (84 kgs)	\$16,258	N/A



Requires RCUF1200 (60hz) or RJC 1275 (50hz) remote condensing unit and RC51 tubing kit. (see page 12)
Recommended Bins: D420, D970. (See page 19-20)
See pages 22-23 for required adapters.
Use cleaner (000000084) only with this model.
Price list performance rating is 60hz data.
Not compatible with SPA/SFA dispensers, iAuCS, or LuminIce II.

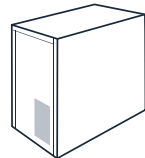

W 22" • D 23.6" • H 26"
W 55.9 • D 59.9 • H 66.0 cm

1092 lbs (495 kgs) daily at 70/50°F*
958 lbs (435 kgs) daily at 90/70°F*

RFF2200

Model	Ice Type	Cooling	Electrical	Shipping Weight	Suggested List Price	Replaces Model
RFF2200C-261	Flake	Remote	208-230v/60hz/1	279 lbs (127 kgs)	\$31,265	RFS2378C-261
RFS2378C-251	Flake	Remote	230v/50hz/1	279 lbs (127 kgs)	\$27,329	N/A

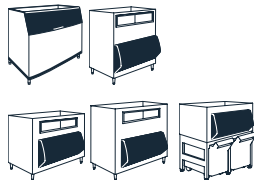

Requires RCUF2200 (60hz) or RJC2375 (50hz) remote condensing unit and RC51 tubing kit. (see page 12)
Recommended Bins: D970, LB1448, LB1460, LB1760, and LBCS1360
(See page 19-20)
See pages 22-23 for required adapters.
Use cleaner (000000084) only with this model.
Price list performance rating is 60hz data.
Not compatible with SPA/SFA dispensers, iAuCS, or LuminIce II.



COUNTERTOP NUGGET



CNF0201:

W 16.25" • D 24" • H 35"
W 41.3 • D 61 • H 106.7 cm

315 lbs (143 kgs) daily at 70/50°F*
222 lbs (101 kgs) daily at 90/70°F*



CNF0202:

W 16.25" • D 24" • H 42"
W 41.3 • D 61 • H 106.7 cm

315 lbs (143 kgs) daily at 70/50°F*
222 lbs (101 kgs) daily at 90/70°F*



K00453: CNF Stand

W 16.25" • D 24" • H 42"
W 41.3 • D 61 • H 106.7 cm

315 lbs (143 kgs) daily at 70/50°F*
222 lbs (101 kgs) daily at 90/70°F*

CNF0201 / 202

Model	Cooling	Use With	Electrical	Shipping Weight	Suggested List Price	Replaces Model
CNF0201A-161L	Nugget	Air	115v/60hz/1	184 lbs (127 kgs)	\$12,419	RNS12A-161
CNF0201A-161	Nugget	Air	115v/60hz/1	184 lbs (127 kgs)	\$12,719	RNS12AT-161
CNF0201A-161N	Nugget	Air	115v/60hz/1	184 lbs (127 kgs)	\$12,719	N/A
CNF0202A-161L	Nugget	Air	115v/60hz/1	198 lbs (90 kgs)	\$15,013	RNS20A-161
CNF0202A-161	Nugget	Air	115v/60hz/1	198 lbs (90 kgs)	\$15,313	RNS20AT-161
CNF0201A-251L	Nugget	Air	230v/50hz/1	184 lbs (127 kgs)	\$12,607	RNS12A-251
CNF0201A-251	Nugget	Air	230v/50hz/1	184 lbs (127 kgs)	\$12,938	RNS12AT-251
CNF0202A-251L	Nugget	Air	230v/50hz/1	198 lbs (90 kgs)	\$15,226	RNS20A-251
CNF0202A-251	Nugget	Air	230v/50hz/1	198 lbs (90 kgs)	\$15,557	RNS20AT-251

Note Dispensing Type: "-161L" is lever activated and "-161" is sensor activated.

3 dispensing options: ice, water, and ice/water together.

Bin capacity is 10 lbs / 4.5 kg for CNF0201 and 20 lbs (9 kgs) for CNF0202.

Legs sold separately, see kit K00345001 below.

Use cleaner (000000084) only with this model.

Not compatible with iAuCS. Price list performance rating is 60hz data.

161N is a solid front panel option, push buttons are covered to make machine completely touchless.

Kit	Description	Electrical	Shipping Weight	Suggested List Price
K00345001	Leg Kit (Adjustable: 4.5 in - 6.5 in / 11.43 - 16.5 cm)	—	3 lbs (1.3 kgs)	\$193
K00377	Kit to convert from lever activated to touchless sensing dispensing option	115/60/1	3 lbs (1.3 kgs)	\$646
K00524	Kit to convert from touchless sensing to lever activated dispensing option	—	3 lbs (1.3 kgs)	\$646
K00514	Solid Front panel replacement for CNF0201 or RNS12, covers buttons to make machine completely touchless	—	10 lbs (5 kgs)	\$374
K00515	Solid Front panel replacement for the CNF0202 or RNS20, covers buttons to make machine completely touchless	—	10 lbs (5 kgs)	\$374
K00453	CNF Stand	—	100 lbs (45.4 kgs)	\$1,495

K00453 has been rated to accommodate weight of 850 lbs. Can be used with the S-150 (without the legs) with either the iT0420 or iT620 Indigo NXT ice machine.

UNDERCOUNTER NUGGET



W 19.69" • D 25.98" • H 33.17"
W 50 • D 66 • H 84.3 cm

220 lbs (100 kgs) daily at 70/50°F*
164 lbs (74 kgs) daily at 90/70°F*



W 29.06" • D 27.17" • H 39.52"
W 73.8 • D 69 • H 100.4 cm

325 lbs (148 kgs) daily at 70/50°F*
286 lbs (130 kgs) daily at 90/70°F*

UNP0200

Model	Ice Type	Cooling	Electrical	Shipping Weight	Suggested List Price	Replaces Model
UNP0200A-161★	Nugget	Air	115v/60hz/1	157 lbs (72 kgs)	\$10,549	UNF0200A-161
UNK0200AZ-251	Nugget	Air	230v/50hz/1	157 lbs (72 kgs)	\$10,718	RNS0244AZ-251

Application ice storage capacity: 30 lbs (14kgs). Measured cubic volume 1.03. Storage capacity is AHRI certified.

Application storage capacity measured 90% of total volume in cubic feet x 22 lbs / ft³

Includes 6 ft (1.8 m) power cord with NEMA 5-15P plug.

Use cleaner (000000084) only with this model.

Not compatible with iAuCS, LuminIce II, or casters.

Price list performance rating is 60hz data. 50 Hz Electric Connection:

Add Z for Bare Lead cord.

UNP0300

Model	Ice Type	Cooling	Electrical	Shipping Weight	Suggested List Price	Replaces Model
UNP0300A-161★	Nugget	Air	115v/60hz/1	224 lbs (102 kgs)	\$12,122	UNF0300A-161
UNK0300AZ-251	Nugget	Air	230v/50hz/1	224 lbs (102 kgs)	\$12,307	RNS0385AZ-251

Application storage capacity: 60 lbs / 27kg. Measured cubic volume 2.04. Storage capacity is AHRI certified.

Application storage capacity measured 90% of total volume in cubic feet x 22 lbs / ft³

Includes 6 ft (1.8 m) power cord with NEMA 5-15P plug.

Use cleaner (000000084) only with this model.

Not compatible with iAuCS, LuminIce II, or casters.

Price list performance rating is 60hz data.

50 Hz Electric Connection: Add Z for Bare Lead cord.

★ **ENERGY STAR® Qualified Model** | Air filter standard on self-contained air-cooled ice cube machines.

* Daily ice production based on half dice air-cooled condenser model at air temperature/water temperature.

MODULAR NUGGET

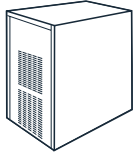

W 22" • D 23.6" • H 26"
W 55.9 • D 60 • H 66 cm

300 lbs (136 kgs) daily at 70/50°F*
259 lbs (117 kgs) daily at 90/70°F*

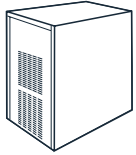

W 22" • D 23.6" • H 26"
W 55.8 • D 60 • H 66 cm

575 lbs (261 kgs) daily at 70/50°F*
463 lbs (210 kgs) daily at 90/70°F*

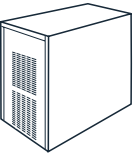

RNF100

W 30" • D 23.62" • H 27.36"
W 76.2 • D 60 • H 69.5 cm
1078 lb (489 kgs) daily at 70/50°F*
825 lb (374 kgs) daily at 90/70°F*

RNF1020C

W 22" • D 23.62" • H 27.36"
W 55.8 • D 60 • H 69.5 cm
1116 lb (506 kgs) daily at 70/50°F*
900 lb (408 kgs) daily at 90/70°F*

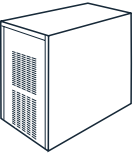

RNF2000C

W 30" • D 23.6" • H 27.4"
1915 lbs (868 kgs) daily at 70/50°F*
1475 lbs (669 kgs) daily at 90/70°F*

Model	Ice Type	Cooling	Electrical	Shipping Weight	Suggested List Price	Replaces Model
RNP0320A-161★	Nugget	Air	115v/60hz/1	174 lbs (79 kgs)	\$10,248	RNF0320A-161
RNK0320AZ-251	Nugget	Air	230v/50hz/1	174 lbs (79 kgs)	\$10,414	RNS0308AZ-251

Recommended Bins: D320 or D420 (see page 19-20) See page 22-23 for required adapters. Use cleaner (000000084) only with this model. All dispenser manufacturers require a nugget ice adapter kit and ice level management kit. Contact beverage dispenser manufacturer or use kit K00488 ice level management kit. Not for use with SPA/SFA dispensers, iAuCS, or LuminIce II. 50 Hz Electric Connection: Add Z for Bare Lead cord.

Model	Ice Type	Cooling	Electrical	Shipping Weight	Suggested List Price	Replaces Model
RNP0620A-161	Nugget	Air	115v/60hz/1	210 lbs (95 kgs)	\$12,634	RNF0620A-161
RNP0620W-161	Nugget	Water	115v/60hz/1	210 lbs (95 kgs)	\$13,397	RNF0620W-161
RNK0620AZ-251	Nugget	Air	230v/50hz/1	210 lbs (95 kgs)	\$12,825	RNS0608A-251
RNK0620WZ-251	Nugget	Water	230v/50hz/1	210 lbs (95 kgs)	\$13,463	RNS0609W-251

Recommended Bins: D420 or D570 (see page 19-20) D-570 will require an adapter, see pages 22-23 Use cleaner (000000084) only with this model. All dispenser manufacturers require a nugget ice adapter kit and ice level management kit. Contact beverage dispenser manufacturer or use kit K00488 ice level management kit. Not compatible with SPA/SFA dispensers, iAuCS, or LuminIce II. 50 Hz Electric Connection: Add Z for Bare Lead cord.

Model	Ice Type	Cooling	Electrical	Shipping Weight	Suggested List Price	Replaces Model
RNF100A-261	Nugget	Air	208-230v/60hz/1	275 lbs (125 kgs)	\$19,011	RNS1008A-261
RNF100W-261	Nugget	Water	208-230v/60hz/1	275 lbs (125 kgs)	\$20,157	RNS1009W-261
RNF1020C-161	Nugget	Remote	115v/60Hz/1	195 lbs (88 kgs)	\$17,955	RNS1078C-161
RNK100AZ-251	Nugget	Remote	230v/50hz/1	275 lbs (125 kgs)	\$19,446	RNS1008AZ-251

Recommended Bins: D970, LB0730, LB1448, LB1460, LB1760, LBCS1360 (see page 19-20) See page 22-23 for required adapters. Requires RCUF1000 remote condensing unit and RC51 tubing kit. Use cleaner (000000084) only with this model. All dispenser manufacturers require a nugget ice adapter kit and ice level management kit. Contact beverage dispenser manufacturer or use kit K00488 ice level management kit. Not compatible with SPA/SFA dispensers, iAuCS, or LuminIce II. 50 Hz Electric Connection: Add Z for Bare Lead cord.

Model	Ice Type	Cooling	Electrical	Shipping Weight	Suggested List Price	Replaces Model
RNF2000C-261	Nugget	Remote	208-230v/60hz/1	279 lbs (127 kgs)	\$24,999	N/A

Recommended Bins: D970, LB0730, LB1448, LB1460, LB1760, LBCS1360 (see page 19-20). Requires RCUF2200 remote condensing unit and RC51 tubing kit. Use cleaner 000000084 only with this model. All dispenser manufacturer require a nugget ice adapter kit and ice level management kit. Contact beverage dispenser manufacturers or use kit K00488 ice level management kit. Not compatible with SPA/SFA dispensers, iAuCS, or LuminIce II.

★ ENERGY STAR® Qualified Model | Air filter standard on self-contained air-cooled ice cube machines.

* Daily ice production based on half dice air-cooled condenser model at air temperature/water temperature.

HOTEL DISPENSERS



ADA Compliant
W 22" • D 31.19" • H* 54"
W 55.9 • D 78.7 H* • 137.2 cm

SPA 162 / SFA 192 SERIES

Model	Application Capacity	Electrical	Shipping Weight	Suggested List Price	Replaces Model
SPA162-161	120 lbs (54 kgs) of storage	115v/60Hz/1	165 lbs (75 kgs)	\$9,021	SPA160-161
SPA162-261	120 lbs (54 kgs) of storage	208-230v/60Hz/1	165 lbs (75 kgs)	\$9,096	SPA160-261
SFA192-161	120 lbs (54 kgs) of storage	115v/60Hz/1	168 lbs (76 kgs)	\$10,419	SFA 191-161
SPA162-251	120 lbs (54 kgs) of storage	230v/50Hz/1	165 lbs (75 kgs)	\$9,090	SPA160-251
SFA192-251	120 lbs (54 kgs) of storage	230v/50Hz/1	165 lbs (75 kgs)	\$10,488	SFA191 -251

SPA162 and SFA192 has Touchless lever ice chute dispense mechanism with push rod. Height adjustable [6 - 7.5 in (15.2 - 19cm)] stainless steel legs included. Accepts single 22 in (55.9cm) Dice or Half Dice size ice machines no larger than IT0620 (order separately) Indigo NXT 22 in (55.9 cm) requires K0034800 baffle (included with dispenser). Dispenser requires separate electrical outlet from the ice machine. SFA models include water valve. Touch-less lever kit K00497 and K00523 kit with push rod are available to upgrade older units (see page 23)



ADA Compliant
W 30" • D 32" • H* 60.5"
W 76.2 • D 81.3 H* • 153.7 cm

SPA 312 / SFA 292 SERIES

Model	Application Capacity	Electrical	Shipping Weight	Suggested List Price	Replaces Model
SPA312-161	180 lbs / 82 kg of storage	115v/60Hz/1	209 lbs (95 kgs)	\$10,632	SPA310-161
SPA312-261	180 lbs (82 kgs) of storage	208-230v/60Hz/1	209 lbs (95 kgs)	\$10,707	SPA310-261
SFA292-161	180 lbs / 82 kg of storage	115v/60Hz/1	214 lbs (97 kgs)	\$11,789	SFA291-161
SPA312-251	180 lbs / 82 kg of storage	230v/50Hz/1	209 lbs (95 kgs)	\$10,702	SPA310-251
SFA292-251	180 lbs / 82 kg of storage	230v/50Hz/1	214 lbs (97 kgs)	\$11,860	SFA291-251

SPA312 and SFA292 has Touchless lever ice chute dispense mechanism. Height adjustable [6 - 7.5 in (15.2 - 19 cm)] stainless steel legs included. Accepts single 22 in (55.9cm)(K00472 adapter required) or 30 in (6.2 cm) Dice or Half Dice size ice machines no larger than IT0750 (order separately) Indigo NXT 30 in (76.2cm) requires K00346 baffle (included with dispenser). Dispenser requires separate electrical outlet from the ice machine. SFA models includes water valve. Touch-less lever kit K00497 and K00523 kit with push rod are available to upgrade older units (see page 23)

*Includes 6" (15.2 cm) adjustable leg

ICE STORAGE BINS



D320
W 22" D 34" H 38"
W 55.9 D 86.4 H 96.5 cm

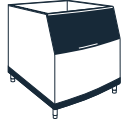

D400
W 30" D 34" H 38"
W 76.2 D 86.4 H 96.5 cm



D420
W 22" D 34" H 50"
W 55.9 D 86.4 H 127.0 cm



D570
W 30" D 34" H 50"
W 76.2 D 86.4 H 127.0 cm

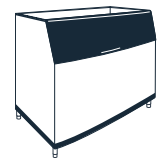

D970
W 48" D 34" H 50"
W 121.9 D 86.4 H 127.0 cm

	Model	Application Capacity	2018 AHRI Capacity Cu ft (Cu m)	Shipping Weight	Suggested List Price	Replaces Model
D-STYLE BINS	D320	264 lbs (119 kgs)	8.9 (0.25)	75 lbs (34 kgs)	\$3,131	B320
	D400	365 lbs (165 kgs)	12.3 (0.37)	91 lbs (41 kgs)	\$3,421	B400
	D420	383 lbs (172 kgs)	12.9 (0.35)	108 lbs (49 kgs)	\$3,256	B420
	D570	532 lbs (241 kgs)	17.9 (0.51)	115 lbs (52 kgs)	\$3,758	B570
	D970	882 lbs (400 kgs)	29.7 (0.84)	150 lbs (68 kgs)	\$5,211	B970



One set of stainless steel legs included in bin price for D-Series bin. Height includes bin legs set at 6 in / 15.2 cm. Legs adjust from 6 - 7.5 in (15.2 - 19.7cm). For bin adapters and ice deflectors, please see page 23

Application Capacity - measured 90% of the total volume in cu. ft x 33 lbs/ft³. 2018 AHRI Capacity is the total internal volume measured in cu. ft.



Ice Storage Bins



LB0730
W 30" • D 34" • H 58"
W 76.2 • 86.4 D • H 147.3 cm



LB1448
W 48" • D 34" • H 67"
W 121.9 • 86.4 D • H 170.2 cm



LB1460
W 60" • D 34" • H 55"
W 152.4 • 86.4 D • H 139.7 cm



LB1760
W 60" • D 34" • H 67"
W 152.4 • 86.4 D • H 170.2 cm



LBCS1360
W 60" • D 36" • H 71"
W 152.4 • 91.4 D • H 180.34 cm

Model	Application Capacity	2018 AHRI Capacity (Cu ft / Cu m)	Shipping Weight	Suggested List Price	Replaces Model
LB0730	683 (309.8)	23 (.65)	275 (124.7)	\$9,384	F-700
LB1448	1337 (606.5)	45 (1.27)	355 (161.0)	\$12,721	F1300
LB1460	1366 (619.6)	46 (1.30)	355 (161.0)	\$13,095	F1325
LB1460-3030	1366 (619.6)	46 (1.3)	355 (161.0)	\$14,851	N/A
LB1760	1693 (619.6)	57 (1.61)	395 (179.2)	\$14,265	F1650
LBCS1360	772 (350.2)	26 (.74)	600 (272.2)	\$36,887	FC-1350
K00512	386 (175.1)	13 (.37)	175 (79.4)	\$4,692	

NOTE: LB1460-3030 includes KLB603030 adapter for two 30" ice machines

Model	Accessory Description	Shipping Weight	Suggested List Price
K00499	48" / 121.9 cm NSF Paddle	5 lbs (2 kgs)	\$555
K00500	37" / 94 cm NSF Shovel	10 lbs (5 kgs)	\$532
K00501	Replacement Set of 6 NSF Totes (16 lb each)	34 lbs (15 kgs)	\$1,285
K00502	Replacement 207 lbs. NSF Ice Cart	75 lbs (34 kgs)	\$4,140
K00503	60" / 152.4 cm NSF Paddle	6 lbs (3 kgs)	\$555
K00504	Replacement Storage Hook	2 lbs (1 kgs)	\$87

NOTES:

K00502 – replacement cart does not include totes or spacer. Totes and spacer sold separately.
Capacity without spacer and totes – 207 lbs. K00501 set of 6 totes, each hold 16 lbs. or 96 lbs total / cart.
LB and LBCS style bins available in Q2 2021

Door and snout ships inside the bin for easy door entry. Add 10.5 inches to the depth of the unit once installed. Guillotine on LBCS1360 can be removed for easy door entry. Adds 4.5 inches to the depth of the unit once installed. K00512 sleeve will add 12" of height to the LBCS1360 when installed.

NOTES:

LB0730, LB1448, LB1460, and LB1760 height includes the bin legs set at 6" (15.2 cm). Legs adjust from 6–7.13" (15.2 to 18 cm) LB0730, LB1448, LB1460, and LB1760 includes – One set of stainless steel legs, ergonomic NSF ice scoop and a storage hook.

LB0730- no additional adapter required for standard 22" and 30" ice machines. Filler panels for a 22" machine included with bin. Additional deflectors required. IB's require additional adapter LB1448, LB1460, & LB1760-no additional adapter required for standard - 22", or 30" or 48" ice machines. Filler panels for 22" and 30" machines included. Additional deflectors required. For IB's and two machines additional adapter and deflectors needed.

LB1448 – when used with the SF3000 or ST300, requires filler panel K00386.

LBCS1360 includes- stainless flange legs, ergonomic NSF ice scoop, two (2) storage hooks, 48" NSF paddle, 2- 207 lbs. NSF carts, six (6) NSF ice totes (16 lbs capacity) with spacer for each cart LBCS1360- no additional adapter required for one standard -22", 30" or 48" ice machine. Filler panels included for 22" and 30" machines. Additional deflectors required. For IB, S3000 or 2 machines, additional adapter and deflectors needed.

K00512: 12" Sleeve- fits on top of the LBCS1360 for 386 lbs. of additional capacity. Adds 12" in height to bin. Sold separately

See page 22 for adapters and deflectors. If using two (2) machines on top, additional adapter and deflectors needed.

Adapters and deflectors designed for Manitowoc ice machines only.



Application Capacity – measured 90% of the total volume in cu. ft x 33 lbs/ft³. AHRI certifies total internal volume measured in cu. ft.

NOTE: Application or Max capacity for ice storage bins varies by manufacturer. For realistic measurement of how much ice a bin will hold without manual intervention, use the AHRI storage capacity. Compare internal cubic volume for an accurate comparison of size.



W45 • D47.5 • H65 cm
UGP00200A
 22 kgs daily at 21/10°C
 16.6 kgs daily at 32/21°C
UGP0030A
 31 kgs daily at 21/10°C
 25.3 kgs daily at 32/21°C

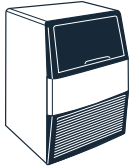

W55 • D55 • H80 cm
UGP0040A
 45 kgs daily at 21/10°C
 36 kgs daily at 32/21°C
UGP0050A
 55.3 kgs daily at 21/10°C
 43 kgs daily at 32/21°C

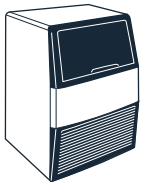

W70 • D60 • H90cm
UGP0080A
 86.4 kgs daily at 21/10°C
 67.5 kgs daily at 32/21°C

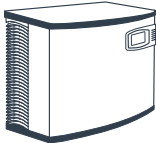

IP0320
 W 55.9 • D 62.2 • H 54.6 cm
 145 kgs daily at 21/10°C
 108 kgs daily at 32/21°C

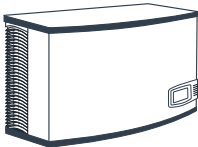

IP0500
 W 76.2 • D 62.2 • H 54.6
 200 kgs daily at 21/10°C
 163 kgs daily at 32/21°C

Model	Ice Type	Cooling	Electrical	Shipping Weight	Suggested List Price	Replaces Model
UGP0020A-251Z	Gourmet	Air	230v/50/Hz/1	45 kg (99 lbs)	\$3,490	UG020A-251
UGP0030A-251Z	Gourmet	Air	230v/50/Hz/1	45 kg (99 lbs)	\$3,603	UG030A-251
UGE0020A-261Z	Gourmet	Air	208-230v/60Hz/1	45 kg (99 lbs)	\$3,490	N/A

Ice Storage Capacity 10 kg. 50 Hz Electric Connection Options: Add letter to end of model number – Z for Bare Lead, F for Schuko Plug, G for Blade Plug and I for Oblique Flat Blade Plug. 60 Hz models offered in Z for Bare Lead. 60Hz 115v add B for grounded power cord. Price list performance rating is 50hz data. Refer to individual 60hz spec sheets for 60hz performance rating. Use cleaner (000006036) only with this model. Not for use with iAuCS cleaning system. Optional Leg Kit K00345001 Contact your local distributor for pricing.

Model	Ice Type	Cooling	Electrical	Shipping Weight	Suggested List Price	Replaces Model
UGP0040A-251Z	Gourmet	Air	230v/50/Hz/1	59 kgs (130 lbs)	\$4,334	UG040A-251
UGP0050A-251Z	Gourmet	Air	230v/50/Hz/1	60 kgs (132 lbs)	\$4,498	UG050A-251
UGF0040A-261Z	Gourmet	Air	208-230v/60Hz/1	59 kgs (130 lbs)	\$4,334	N/A
UGF0050A-161B	Gourmet	Air	115v/60Hz/1	60 kgs (132 lbs)	\$4,498	N/A
UGF0050A-261Z	Gourmet	Air	208-230v/60Hz/1	60 kgs (132 lbs)	\$4,498	N/A

Ice Storage Capacity 25 kg. 50 Hz Electric Connection Options: Add letter to end of model number – Z for Bare Lead, F for Schuko Plug, G for Blade Plug and I for Oblique Flat Blade Plug. 60 Hz models offered in Z for Bare Lead. 60Hz 115v add B for grounded power cord. Price list performance rating is 50hz data. Refer to individual 60hz spec sheets for 60hz performance rating. Use cleaner (000006036) only with this model. Not for use with iAuCS cleaning system. Optional Leg Kit K00345001 Contact your local distributor for pricing.

Model	Ice Type	Cooling	Electrical	Shipping Weight	Suggested List Price	Replaces Model
UGP0080A-251Z	Gourmet	Air	230v/50/Hz/1	72 kgs (159 lbs)	\$5,324	UG080A-251
UGF0080A-261Z	Gourmet	Air	208-230v/60Hz/1	72 kgs (159 lbs)	\$5,324	N/A

Ice Storage Capacity 44 kg, 50 Hz Electric Connection Options: Add letter to end of model number – Z for Bare Lead, F for Schuko Plug, G for Blade Plug and I for Oblique Flat Blade Plug. 60 Hz models offered in Z for Bare Lead. Price list performance rating is 50hz data. Refer to individual 60hz spec sheets for 60hz performance rating. Use cleaner (000006036) only with this model. Not for use with iAuCS cleaning system. Optional Leg Kit K00345001 Contact your local distributor for pricing.

Model	Ice Type	Cooling	Electrical	Shipping Weight	Suggested List Price	Replaces Model
IDP0320A-251*	Dice	Air	230v/50/Hz/1	62 kgs (137 lbs)	\$9,815	N/A
IYP0320A-251	Half Dice	Air	230v/50/Hz/1	64 kgs (138 lbs)	\$9,815	IYP0324A-251
R290 Propane Refrigerant						
IDP0500A-251*	Dice	Air	230v/50/Hz/1	65 kgs (144 lbs)	\$10,955	N/A
IYP0500A-251	Half Dice	Air	230v/50/Hz/1	66 kgs (146 lbs)	\$10,955	IYP0504A-251
R290 Propane Refrigerant						

*Daily ice production estimated based on 50 Hz, Half Dice air cooled condenser model at air temperature/ water temperature indicated. For actual, reference spec sheet.

BIN ADAPTORS & ICE DEFLECTOR KITS

Kit	Description	Shipping Weight	Suggested List Price
K00472	Bin Adapter: for 22"/55.9 cm Indigo NXT, RFF, RNF ice machines on a 30"/70.6 cm D 400, 570 or 30"/72.6 cm Hotel Dispenser. Not for IB	8 lbs (4 kgs)	\$474
K00473	Bin Adapter: for 22"/55.9 cm Indigo NXT, RFF, RNF on a D970 bin. Not for IB	35 lbs (16 kgs)	\$796
K00371	Bin Adapter for two 22"/55.9 cm RFP,RNP (water or QQ) or Indigo NXT (with Top air discharge or water cooled) on a D970 bin.	8 lbs (4 kgs)	\$426
K00470	Bin Adapter: for 30"/76.2 cm Indigo NXT, RFF, RNF ice machines on a 48"/121.9 cm D970 Bin	34 lbs (15 kgs)	\$796
K00471	Front and center deflector for 30"/76.2 dual ice machines, IF1400C, 1800C or 2100C on a 48" /121.9 cm D970 Bin. (Must also use the K00470) Remove the existing deflector in the D970 prior to installing	13 lbs (6 kgs)	\$474
K00382	Ice Deflector required for 30" (72.6 cm) for I1400C, I1800C, or I2100C on a Non-Manitowoc or F-Style Bin	8 lbs (4 kgs)	\$294
K00383	Ice Deflector required for: two 30"/72.6 cm for I1400C, I1830C or I2100C on a non-Manitowoc or LB & F-style Bin	18 lbs (8 kgs)	\$490
K00347	Ice Deflector required for: 30"/76.2 cm Indigo NXT with front facing evaporators on a non-Manitowoc or LB & F-style Bin	5 lbs (3 kgs)	\$290
K0034900	Ice Deflector required for: 48"/121.9 cm Indigo NXT on a non-Manitowoc or LB & F-style Bin	10 lbs (5 kgs)	\$342
K00391	Ice Deflector set required for S3000 ice machine on a non-Manitowoc or 48"/121.9 cm or 60" /152.4 cm LB & F-style Bin	18 lbs (8 kgs)	\$951
K00420	Filler Panel Kit allows 22"/55.9 cm RNF1020C to be places on a F-style bin with 48" and 60" opening (for use with adapter included with bin)	5 lbs (3 kgs)	\$297
K00421	Filler Panel Kit allows for two side by side 22" /55.9 cm RNF1020C to be place on a F -style bins with 60"/152.4 cm opening	5 lbs (3 kgs)	\$297
K303000	Replacement Bin Adapter for 30"/76.2 cm Indigo NXT Series Cuber on a F700 Bin (Included with bin)	45 lbs (20 kgs)	\$1,519
K483048	Replacement Bin Adapter for 30"/76.2 cm and 48"/121.9 cm Indigo NXT Series Cuber on a F1300 Bin (Included with bin)	45 lbs (20 kgs)	\$1,518
K603048	Replacement Bin Adapter for 30"/76.2 cm and 48"/121.9 cm Indigo NXT Series Cuber on a F1325 or F1650 Bin (included with the bin)	52 lbs (24 kgs)	\$1,759
K604800	Bin Adapter for SF3000C & ST3000W on a F1325 or F1650 Bin	52 lbs (24 kgs)	\$1,984
K603030	Bin Adapter for two 30"/ 76.2 cm Indigo NXT Series Cubers Side by Side on a F1325 or F1650 Bin (remote or water cooled)	52 lbs (24 kgs)	\$1,759
K00396	Filler Panel for SF3000C or ST3000W on a LB1448	5 lbs (3 kgs)	\$297
K00513	Ice Deflector required for 30" (72.6 cm) for I1400C, I1800C, or I2100C on LB730, LB1448, LB1460, LB1760. (1 inch longer than the K00382 due to the opening size on the tops being larger than others)	5 lbs (3 kgs)	\$297
K00506	Replacement Filler Panels for 22 inch machine on a LB0730 (included with bin)	5 lbs (3 kgs)	\$347
K00508	Replacement Filler Panels for 22 inch machine on a LB1448/1460/1760 (included with bin)	5 lbs (3 kgs)	\$347
K00509	Replacement Filler Panels for 30 inch machine on a LBCS1360 (included with bin)	5 lbs (3 kgs)	\$385
K00510	Replacement Filler Panels for 22 inch machine on a LBCS1360 (included with bin)	5 lbs (3 kgs)	\$347
KLB302230	Replacement Bin Adapter for 22" /55.9 cm and 30"/76.2 cm Indigo NXT, RFF or RNF on a LB730 Bin (included with bin)(adapter is included with bin- the replacement consist of the poly top adapter and the metal under frame)	40 lbs (18 kgs)	\$1,582
KLB482214	Required bin adapter for 2-22"/55.9 cm Ice Beverage (IB) side by side on LB1448	45 lbs (20 kgs)	\$2,242
KLB604800	Required Bin Adapter for SF3000C & ST3000W on a LB1460 or LB1760 Bin	74 lbs (34 kgs)	\$2,242
KLB602222	Required Bin Adapter for 2-22" / 55.9 cm side by side Quite Qube Indigo NXT, RFF or RNF, water cooled Indigo NXT, RFF or RNF or Indigo NXT air cooled with top air discharge on a LB1460 or LB1760	52 lbs (24 kgs)	\$2,242
KLB602214	Required Bin Adapter for 2-22" / 55.9 cm Ice Beverage (IB) side by side on a LB1460 or LB1760	52 lbs (24 kgs)	\$2,242
KLB603030	Required Bin Adapter for 2-30"/76.2 cm Indigo NXT side by side on LB1460 or LB1760 Bins (remote, water cooled or Top Air discharge)	60 lbs (27 kgs)	\$1,756
KLB613048	Replacement Bin Adapter for 22"/55.9 cm 30"/76.2 cm or 48"/121.9 cm Indigo NXT RNF or RNF on a LBCS1360 (included with bin)(adapter is included with bin- the replacement consist of the poly top adapter and the metal under frame)	60 lbs (27 kgs)	\$1,711
KLB614800	Required Bin Adapter for SF3000C & ST3000W on a LBCS1360 Bin	77 lbs (35 kgs)	\$2,369
KLB612214	Required Bin Adapter for 2-22" / 55.9 cm side by side Ice Beverage (IB) on a LBCS1360	60 lbs (27 kgs)	\$2,369
KLB612222	Required Bin Adapter for 2-22" / 55.9 cm side by side Quite Qube Indigo NXT, RFF or RNF, water cooled Indigo NXT, RFF or RNF or Indigo NXT air cooled with top air discharge on a LBCS1360	60 lbs (27 kgs)	\$2,369
KLB613030	Required Bin Adapter for 2- 30" / 76.2 cm Indigo NXT, RFF or RNF side by side on a LBCS1360 Bins (remote, water cooled or Indigo NXT with Top Air Discharge)	60 lbs (27 kgs)	\$2,369
K00457	DISPENSER THERMOSTAT KIT – For use with S-Series. For use on Soda dispensers only. An ice dispenser thermostat kit may be required for high humidity locations to reduce equipment sweating. Replaces K00364.	3 lbs (1 kgs)	\$540
K00446	DISPENSER THERMOSTAT KIT – For use with Indigo Series only on Soda dispensers. An ice dispenser thermostat kit may be required for high humidity locations to reduce equipment sweating.	4 lbs (2 kgs)	\$350
K00477	DISPENSER THERMOSTAT KIT – For use with Indigo NXT series only on soda dispensers. An ice dispenser thermostat kit may be required for high humidity locations to reduce equipment sweating.	4 lbs (2 kgs)	\$350
K00456	DISPENSER THERMOSTAT KIT – For use with Indigo Series only on Freestyle beverage dispensers. An ice dispenser thermostat kit may be required for high humidity locations to reduce equipment sweating.	3 lbs (1 kgs)	\$337
K00478	DISPENSER THERMOSTAT KIT – For use with Indigo NXT Series only on Freestyle beverage dispensers. An ice dispenser thermostat kit may be required for high humidity locations to reduce equipment sweating.	3 lbs (1 kgs)	\$337
K00488	DISPENSER THERMOSTAT KIT – For use with nugget machines on soda dispensers. An ice dispenser thermostat kit may be required for high humidity locations to reduce equipment sweating.	3 lbs (1 kgs)	\$540
K00346	DISPENSER BAFFLE - required for use with any Manitowoc 30" / 76.2 cm Indigo NXT series ice machine in a soda dispenser application. Dispenser baffle included with S-Series hotel dispensers, no need to order. NOT required for iF1400C and iF1800C.	3 lbs (1 kgs)	\$118
K0034800	DISPENSER BAFFLE – required for use with any Manitowoc 22" / 55.9 cm Indigo NXT Series ice machine in a Soda dispensers application. Dispenser baffle is included with S-Series Hotel dispensers, no need to order.	3 lbs (1 kgs)	\$133

MISCELLANEOUS

Kit	Description	Shipping Weight	Suggested List Price
K00395	S3000 BIN THERMOSTAT KIT – For use with S3000.	3 lbs (1 kgs)	\$780
K00483	DISPENSER THERMOSTAT KIT – for use with nugget machines on Freestyle 9000. An ice dispenser thermostat kit may be required for high humidity locations to reduce equipment sweating.	4 lbs (2 kgs)	\$1,058
K00487	DISPENSER THERMOSTAT KIT - for use with nugget machines on Freestyle 9100. An ice dispenser thermostat kit may be required for high humidity locations to reduce equipment sweating.	4 lbs (2 kgs)	\$668
K00497	TOUCHLESS LEVER ACTIVATED ICE CHUTE – Updates the Push to Touch SPA's and SFA's to Touchless. Use for buckets, tumblers and water bottles.	3 lbs (1 kgs)	\$228
K00522	SPA TO SFA CONVERSION KIT – Converts a SPA to an SFA Hotel Dispenser. Works with 22" and 30" SPA Hotel Dispensers	5 lbs (2 kgs)	\$747
K00523	Use to update "Push for ice" chutes to Touchless lever activated chute for SPA and SFA hotel Dispenser. Use with ice buckets and water bottles	3 lbs (1 kgs)	\$266
K00526	Required for 30" Indigo NXT Twin Evaporator ice machine heads (IF1400C, IT1430, IT1830, IF2100) on top of a Cornelius ProGate IDC255 Dispenser	1 lb (0.5 kg)	\$160

BIN ADAPTERS & DEFLECTORS

ICE STORAGE BINS	BIN	Machines	IT0420, IT0620	IT0300	IT0450, IT0500, IF0500N	IF0600N, IT0750, IF0900N, IT0900	IT1200	IT1500, IT1900
	D320	1		N.A.	N.A.	N.A.	N.A.	N.A.
	D400	1	K00472					N.A.
	D420	1		N.A.	N.A.	N.A.	N.A.	N.A.
	D570	1	K00472					N.A.
	D970	1	K00473	K00470	K00470	K00470	K00470	N.A.
		2	K00371	N.A.	N.A.	N.A.	N.A.	N.A.
	F700 / LB0730	1	N.A.	N.A.	K00347	K00347	K00347	N.A.
	F1300 / LB1448	1	N.A.	N.A.	K00347	K00347	K00347	K0034900
	F1325 / LB1460	1	N.A.	N.A.	K00347	K00347	K00347	K0034900
F1650 / LB1760	1	N.A.	N.A.	K00347	K00347	K00347	K0034900	
FC1350 / LBCS1360	1	N.A.	N.A.	K00347	K00347	K00347	K0034900	
SPA162, SFA192	1		N.A.	N.A.	N.A.	N.A.	N.A.	
SPA312, SFA292	1	K0034800 & K00472				N.A.	N.A.	
Non-Manitowoc Dispensers	1	K0034800 (baffle)	K00346 (baffle)	K00346 (baffle)	K00346 (baffle)	K00346 (baffle)	N.A.	

N.A. means not a practical application or no adapter option available

ICE STORAGE BINS	BIN	Machines	IF0600C, IF0900C, IT1200C	IF1400C, IT1830C, IF2100C	IBF0620C, IFB0820C, IBT1020C	RNF,RFF0320, RNF, RFF0620, RNF1020C, RFF1220C	RFF1300, RNF1100, RNF2000C, RFF2200C	ST3000W, SF3000C
	D320	1	N.A.	N.A.	N.A.		N.A.	N.A.
	D400	1		N.A.	N.A.	K00472	N.A.	N.A.
	D420	1	N.A.	N.A.	N.A.		N.A.	N.A.
	D570	1		N.A.	N.A.	K00472	N.A.	N.A.
	D970	1	K00470	K00470, K00471	N.A.	K00473	K00470	N.A.
		2	N.A.	N.A.	N.A.	K00371	N.A.	N.A.
	F700	1	K00347	K00382	N.A.	N.A.		N.A.
	LB0730	1	K00347	K00382	N.A.			N.A.
	F1300	1	K00347	K00382	N.A.	N.A.		K00391
LB1448	1	K00347	K00513	N.A.			K00391, K00396	
	2	N.A.	N.A.	N.A.	N.A.	N.A.	N.A.	
F1325, F1650	1	K00347	K00382	N.A.			K00391, K604800	
	2	K00347(2), K603030	K00383, K603030	N.A.	K00421 & K603030	K603030	N.A.	
LB1460, LB1760	1	K00347	K00513	N.A.			K00391, KLB604800	
	2	K00347(2), KLB603030	K00383, KLB603030	KLB602214	KLB602222	KLB603030	N.A.	
FC1350	1	K00347	K00382	N.A.			K00391, K614800	
	2	K00347(2), K613030	K00383, K613030	N.A.	K00421, K613030	K613030	N.A.	
LBCS1360	1	K00347	K00382	N.A.			K00391, KLB614800	
	2	N.A.	N.A.	KLB612214	KLB612222	N.A.	N.A.	
SPA162, SFA192	1	N.A.	N.A.	K00195	N.A.	N.A.	N.A.	
SPA312, SFA292	1	N.A.	N.A.	K00196	N.A.	N.A.	N.A.	
Non-Manitowoc Dispensers	1	K00346 (baffle)	N.A.	N.A.	N.A.	N.A.	N.A.	

NOTE: Adapter included with single head application unless otherwise indicated. Deflectors are required for F and LB bins. N.A. means not a practical application or no adapter option available.

Accessory prices are now included in the standard equipment suggested price list.

QUIET TUBE & IB REMOTE TUBING KITS & ACCESSORIES

Kit	Description	Shipping Weight	Suggested List Price
iAuCS® AUTOMATIC CLEANING SYSTEM			
IAUCS-161 IAUCS-261	Automatic Cleaning System Accessory for all Indigo and Indigo NXT Series ice machines 300 to 2100. Cannot be used with Indigo IB Series, S-Series, nugget, flake and undercounter units. This option is installed on the outside of the machine and works in conjunction with cleaner and sanitizer bottle numbers 000005162 or 000005164. Installed outside of machine but electrical is supplied from the machine. When ordering, indicate electrical requirements; 115 volt 60 Hz -iAuCS-161, and 230 volt 60 Hz - iAuCS-261.	11 lbs (5 kgs)	\$1,180
IBAUCS-161	Automatic Cleaning System Accessory for Indigo IB Series ice machines: IBF0620C, IBF0820C, IBT1020C. Cannot be used with Indigo Series ice machines 300 to 2100, S-Series, nugget, flake and undercounter units. This option is installed on the outside of the machine and works in conjunction with cleaner and sanitizer bottle numbers 000005162 or 000005164. Installed outside of machine. Electrical requirements 115 volt 60 Hz. Includes 10' power cord with NEMA 5-15P plug.	11 lbs (5 kgs)	\$1,180
NOTE: iAuCS Automatic Cleaning System cannot be used with flake and nugget ice machines.			
LUMINICE® II VIRUS AND BACTERIA INHIBITOR			
K00450	LuminIce II Virus and Bacteria Inhibitor kit for Indigo units i300 to i1106 and QQ models	5 lbs (2.2 kgs)	\$890
K00519	LuminIce II Virus and Bacteria Inhibitor kit for NEO Undercounters UF0140 to UF0310 (Replaces K00452)	5 lbs (2.2 kgs)	\$890
K00464	LuminIce II Virus and Bacteria Inhibitor kit for Indigo NXT models: iT0300, iT420, iT620, iT450, iT500, iF0600, iT0750, iF0900, iT1200 and QQ iF0600C, iF0900C, iT1200C	5 lbs (2.2 kgs)	\$890
K00465	LuminIce II Virus and Bacteria Inhibitor kit for Indigo NXT models: iT1500 & iT1900 and IBF0620C, IBF0820C, IBT1020C and iF1400C, iT1830C, iF2100 (Indigo NXT 48 in, IB's, Duals)	5 lbs (2.2 kgs)	\$890
K00474	Converts K00450 or K00451 to work with appropriate Indigo NXT model	0.5 lbs (0.23 kgs)	\$28
K00425	Replacement LuminIce bulb for Luminice first generation only (bulb with white end caps) Indigos built prior to July 1, 2015	0.5 lbs (0.23 kgs)	\$151
K00454	Replacement LuminIce II bulb for LuminIce II only (bulb with blue end caps) Indigos and Indigo NXT built after July 1, 2015	0.5 lbs (0.23 kgs)	\$151
K00455	Remote Luminice II external LED indicator- for Luminice II and Indigo only	0.5 lbs (0.23 kgs)	\$82
K00528	High intensity Luminice II bulb (Use for larger machines and challenging conditions)	0.5 lbs (0.23 kgs)	\$151
Selected models can be ordered from the factory with the kit already installed. (See model price pages) Other Indigo® NXT models and all Neo® models can have the Luminice II kit added after market. Parts (non "K" kits) must be ordered through distributors.			
LIQUID DESCALER AND SANITIZER FOR CUBER MACHINES			
000005162 000005164	Liquid Descaler: 16 oz / .47 liter bottle (sold in cases of 12) Liquid Sanitizer: 16 oz / .47 liter bottle (sold in cases of 12)	16 lbs (7 kgs) 16 lbs (7 kgs)	SEE PARTS
94-0580-3 94-0581-3	Liquid Descaler: 1 gallon / 3.78 L (sold in cases of 4) Liquid Sanitizer: 1 gallon / 3.78L (sold in cases of 4)	42 lbs (19 kgs) 42 lbs (19 kgs)	SEE PARTS
LIQUID DESCALER AND SANITIZER FOR SM-50, CONTINUOUS MACHINES (FLAKE, NUGGET, CNF)			
000006036	Liquid Metal-safe Descaler 16 oz / .47 Liter bottle (sold in cases of 12) Hazardous labeling for International Shipments	16 lbs (7 kgs) 16 lbs (7 kgs)	SEE PARTS
000000084	Liquid Metal-safe Descaler 16 oz / .47 Liter bottle (sold in cases of 12) Non-Hazardous labeling for US Shipments only	16 lbs (7 kgs) 16 lbs (7 kgs)	SEE PARTS
000005164	Liquid Sanitizer: 16 oz / .47 Liter bottle (sold in case of 12) Hazardous labeling for International Shipments	16 lbs (7 kgs)	SEE PARTS
POWDER DESCALER AND RINSE FOR CUBER MACHINES AMERICAS MARKETS			
000016265 000016278	Powder Descaler: 3 oz / 85 g (sold in cases of 48 packets) E/S/F Powder Rinse: 1.2 oz / 34 g (sold in cases of 48 packets) E/S/F	11 lbs (4 kgs) 6 lbs (3 kgs)	SEE PARTS
000016287 000016291	Powder Descaler Starter Kit (Sold in cases of 6 boxes) Powder Rinse Starter kit: (Sold in cases of 6 boxes)	7 lbs (kgs) 5 lbs (2 kgs)	SEE PARTS
Starter kits include: 8 packets, Mixing vessel with lid, instruction sheet. Language: English/Spanish/French			
POWDER DESCALER AND RINSE FOR CUBER MACHINES ASIAN MARKETS			
000016272 000016283	Powder Descaler: 3 oz / 85 g (sold in cases of 48 packets) C/K/E Powder Rinse: 1.2 oz / 34 g (sold in cases of 48 packets) C/K/E Hazardous labeling for Air Shipments - Language Chinese/Korean/English	11 lbs (4 kgs) 6 lbs (3 kgs)	SEE PARTS
000016525 000016528	Powder Descaler: 3 oz / 85 g (sold in cases of 48 packets) E/C/K Powder Rinse: 1.2 oz / 34 g (sold in cases of 48 packets) E/C/K Hazardous labeling for Air Shipments - Language English/ Chinese/Korean	11 lbs (4 kgs) 6 lbs (3 kgs)	SEE PARTS



Kit	Description	Shipping Weight	Suggested List Price
K00206	6 ea. replacement packets, 1 ea basket, zip ties. For use in Q and S-Series ice machines only. Cannot be used with SF3000C, S3000, Indigo, nugget, flake, or undercounter ice machines.	1 lb (0.5 kg)	\$421

CLEANAIR™ PACK



Kit	Description	Shipping Weight	Suggested List Price
AR-Pre-P	Arctic Pure Plus: Pre-filter assembly includes head, shroud, hardware, mounting assembly and one filter cartridge. Use on all machines (Price is for one system, sold in case of 6).	21 lbs (10 kgs)	\$425
AR-10000-P	Arctic Pure Plus: Primary filter assembly includes head, shroud, hardware, mounting assembly and one filter cartridge. See sizing guide. (Price is for one system, sold in case of 6).	25 lbs (11 kgs)	\$589
AR-20000-P	Arctic Pure Plus: Primary filter assembly includes head, shroud, hardware, mounting assembly and one filter cartridge. See sizing guide. (Price is for one system, sold in case of 6).	20 lbs (9 kgs)	\$779
AR-40000-P	Arctic Pure Plus: Primary filter assembly includes head, shroud, hardware, mounting assembly and one filter cartridge. See sizing guide. (Price is for one system, sold in case of 6).	24 lbs / 11 kg	\$973
Arctic Pure PLUS Replacement cartridges sold in cases quantities Indicated below:			
K00496	AR-PRE-P replacement cartridge (Price is for case of 12).	22 lbs (10 kgs)	\$1,394
K00493	AR-10000-P replacement cartridge (Price is for case of 12).	29 lbs (13 kgs)	\$2,325
K00494	AR-20000-P replacement cartridge (Price is for case of 12).	19 lbs (9 kgs)	\$3,485
K00495	AR-40000-P replacement cartridge (Price is for case of 12).	27 lbs (12 kgs)	\$5,409

ARCTIC PURE PLUS - WATER FILTER



Kit	Description	Shipping Weight	Suggested List Price
Arctic Pure Replacement cartridges sold in cases quantities indicated below:			
K00374001	AR2800 replacement cartridge (Price is for case of 12) Use on SMS50A / UCP50A / USE50A	11 lbs (5 kgs)	\$1,507
K00337	AR-PRE replacement cartridge (Price is for case of 12).	22 lbs (10 kgs)	\$1,394
K00338	AR-10000 replacement cartridge (Price is for case of 12).	33 lbs / 15 kg	\$2,325
K00339	AR-20000 replacement cartridge (Price is for case of 6).	10 lbs / 4 kg	\$1,742

ARCTIC PURE PLUS WATER FILTER CARTRIDGES

Filter Systems (Replacement Cartridges)	AR-PRE (K00337) AR-PRE-P (K00496)	AR-10000 (K00338) AR-10000-P (K00493)	AR-20000 (K00339) AR-20000-P (K00494)	AR-40000 (2-K00339) AR-40000-P (K00495)
All Under Counters				
(Cubers, Flakers & Nuggets)	X	X		
Counter Top Nugget				
Modular Cubers: IT0300-IT750, IBF0620				
Modular Flaker: RFP0320	X	X		
Modular Nugget: RNP0320				
Modular Cubers: IT0900, IBF0820C & IBT1020C				
Modular Flaker: RFP0620, RFF1220C, RFF1300	X		X	
Modular Nuggets: RNF0620, RNF1020C, RNF1100				
Modular Cubers: IT1200, IT1500 & IT1900, IF1400C, IT1830C & IF2100C				
Modular Flaker: RFF2200C	X			X
Modular Nugget: RNF2000C				

WATER FILTER SIZING GUIDE

NOTE: ARCTIC PURE PLUS AND ARCTIC PURE CARTRIDGES ARE NOT COMPATIBLE



Kit	Description	Shipping Weight	Suggested List Price
K00146	Ice bagger assembly, includes bagger, B-Model bin adapter, and 250 bags and ties. Stainless steel finish.	25 lbs (11 kgs)	\$1,082
K00068	Replacement Bags/Ties Bag Kit - Includes 1,000 bags (4 wickets of 250) and ties.	34 lbs (15 kgs)	\$619



Kit	Description	Shipping Weight	Suggested List Price
3302583	6 oz./.18L clear scoop for QM and SM Series (each)	2 lbs (1 kgs)	See Parts
40002930	22 oz./.65L blue scoop (Used with Neo undercounter units.)	3 lbs (1 kgs)	See Parts
040004889	32 oz./.95L white scoop (each)(Used for B170 and Q-Series undercounter units.)	3 lbs (1 kgs)	See Parts
3302593	82 oz./2.4L white scoop (each)(Used for ice bin D320 and up.)	5 lbs (2 kgs)	See Parts
000015595	5.3 lb / 2.4 kg capacity, NSF approved, blue ABS plastic with knuckle guard, works inside D-Bin or with optional K00461 External Scoop Holder	5.3 lbs (2.4 kgs)	See Parts
K00463	5.3/lbs/2.4kg capacity NSF approved aluminum with knuckle guard. Has limited lifetime guarantee. Works inside D-bins or with optional K00461 External scoop holder	11 lbs /5 kg	\$177

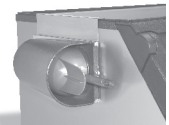

Kit	Description	Shipping Weight	Suggested List Price
K00461	Protects the ice scoop outside the bin. NFS versatile holder can be configured seven ways on the bin or wall. Use with 000015595 scoop that comes with D-Bins, aluminum scoop K00463 (To use K00461 with LB Style bins, you must also purchase the K00482 hanger)	11 lbs (5 kgs)	\$237
K00482	Hanger for LB-Style bins to be used with the K00461 External scoop holder	5 lbs (2 kgs)	\$57



Kit	Description	Shipping Weight	Suggested List Price
K00064	2.5" (6.35 cm) Casters. For use with NEO, Q-Series (not QM or UDE), and B170 bin. two (2) ea. locking swivel and two (2) ea. non-locking swivel.	2 lbs (1 kgs)	\$510
K00153	4.625" (11.75 cm) Adjustable Flange Foot - stainless steel (Use with Bins only)	5 lbs (2 kgs)	\$400
K00176	4" (10.16 cm) leg for UDE0065/80 - black painted	3 lbs (1 kgs)	\$214
K00215	UDE Series leveler legs, adjusts from 0.5"-1.25" (1.27-3.175 cm) - 1/2-13 thread	1 lb / 1 kg	\$104
K00145	6" (15.24 cm) Adjustable Secured Flange Foot - stainless steel (Use with B-Bins only) includes latch bracket #6072421	6 lbs (3 kgs)	\$544
K00144	12" (30.48 cm) Adjustable Flange Foot - stainless steel. Can use with Neo undercounter machines and B170 and B&D 400 Bin. Not for use with 22" (52.9 cm) unit, stacked units, dispensers, or the QM or UDE series.	8 lbs (4 kgs)	\$544
K00138	Adjustable Caster Legs, 7.625-8.625" (19.4 - 21.9 cm) - stainless steel. Not for use with 22" (52.9 cm) unit, or any stacked units, dispensers, QM's, UDE or UFP or UNP. two (2) locking casters and two (2) non-locking per set.	16 lbs (7 kgs)	\$1,117
K00350	6" (15.24 cm) Adjustable Legs - stainless steel standard on B&D Series bins.	5 lbs (2 kgs)	\$190
K00345001	Leg kit for SM50 & CNF201/202 series ice machines. Adjustable 4.5" to 6.4" (1.43-16.51 cm.)	3 lbs (1 kgs)	\$193
K00445	1.125" (2.9 cm) Non-adjustable foot. For use with NEO.	2 lbs (1 kgs)	\$105
K00462	Secure fastening kit, includes 6" (15.24cm) adjustable flanged foot, stainless steel with latching hardware. Use with D-Bins and Indigo units only	6 lbs (3 kgs)	\$675

Parts (non "K" kits) must be ordered through distributors.



AHRI CERTIFIED – Manitowoc Ice Machines and D-Bins are certified by The American Heating and Refrigeration Institute. (AHRI) This means the data we published is validated to be true based on ASHRAE standards. Our certified products are continually tested by an independent third party laboratory to validate our products perform to the ratings or specifications published. Rest assured, products that carry the AHRI label comply to their publish specification. AHRI rates ice machine performance is rated at the 90 ambient temperature and 70 water temperature. Bin capacity rating is measured by the cubic volume of the interior of the bin.



ENERGY STAR – Manitowoc Ice is an avid supporter of the EPA's voluntary ENERGY STAR program. We believe in making ENERGY STAR approved ice machines are not only good for the environment but it makes good business sense. In fact, we have more ENERGY STAR models than any other ice machine manufacture. Moreover, Manitowoc Ice is a key contributor to the ENERGY STAR Partner of the Year award winners for 14 consecutive years. Look for the ★ next to the model number to indicate whether a model is ENERGY STAR qualified, then check with your local dealer if it is rebate eligible.



BEST IN CLASS – Foodservice Equipment & Supplies (FE&S) magazine conducts an annual survey among its subscribing foodservice operators, dealers, and consultants asking them to evaluate ice machines in the categories of: quality, value, design, service and support, sales and support, inventory and availability. For 17 consecutive years Manitowoc Ice has been voted best in class. Don't take our word for it; take it from the people who know ice machines.



KITCHEN INNOVATION AWARD 2019 – Indigo NXT, was awarded the 2019 Kitchen Innovation Award from the National Restaurant Association. This prestigious award recognizes Indigo NXT for its innovation, efficiencies and productivity.

KITCHEN INNOVATION AWARD 2021 – CrystalCraft Premier was awarded the 2021 Kitchen Innovation Award from the National Restaurant Association. This prestigious award recognizes the CrystalCraft Premier for its innovative design and perfectly formed crystal clear square cube.



INTELLIGENT ICE MACHINE – Manitowoc Indigo NXT with its easyTouch display is the only ice machine that offers a touch display providing the user and service agent with vital information to facilitate the set up and operation of the equipment. The display provides 4 main statuses: Making Ice, Bin Full, Machine Off or Program Mode. All the asset information can be obtained with one touch of an icon. Set up reminders to clean, change the air and water filters can be programmed easily into the machine. You can program the machine NOT to make ice when the store is closed or during the hours of the day of higher energy costs. The self diagnostic feature stores vital information for the service agent to access, so when they arrive, they have a good idea of the problem. This makes servicing easier, reduces labor costs and reduces machine down time.



EASY TO CLEAN – Manitowoc Indigo Machines are the easiest ice machines in the industry to clean. All the component parts that require a deep cleaning can be removed without the use of tools. This includes the water trough as well as the water pump. Selected components contain Alpha San- Antimicrobial compound molded into the plastic to reduce slime build up.

ENERGY EFFICIENT – Having the most ENERGY STAR models is a result of advance technologies that allow the Indigo NXT ice machine to work efficiently. Innovations like Air Assist which accelerates the ice harvest process and the Acoustical Ice Sensing probe allows for reliable operation in challenging water conditions. Air Assist and Acoustical Ice sensing are patent technologies only found on Manitowoc Indigo machines.



LUMINICE II VIRUS AND BACTERIA INHIBITOR – Manitowoc Indigo NXT and Neo machines offer the LuminIce II Virus and Bacteria Inhibitor device that runs quietly 24/7 keeping your ice machine cleaner longer. Less frequent cleanings saves labor, reduces cost and machine downtime. The device is particularly effective in environments where yeast is in the air (sandwich shops, bakeries, pizzerias, micro-breweries) because the LuminIce II device uses a UV bulb to create active air that inhibits the growth of viruses, bacteria, mold and yeast inside the machine. The device is mounted inside the machine, and is integrated with the easy Touch Display with an icon that lets you know the operational status.



AUTOMATIC CLEANING SYSTEM - (iAUCS) – Manitowoc Ice automatic cleaning system is a perfect complement to the LuminIce II virus and bacteria inhibitor. Using the easyTouch display on the Indigo NXT Ice machine, program the time interval to either clean or sanitize the food zone automatically. No manual intervention is required. This is especially effective in areas of hard water, where periodic cleaning of the evaporator will keep the evaporator free of lime scale build up. (Note, iAUCS will not eliminate the need to do a deep cleaning periodically) but will keep your machine running at peak efficiency and cleaner longer).

SCAN TO LOCATE A DEALER, DISTRIBUTOR OR
SALES REPRESENTATIVE IN YOUR AREA



OR VISIT
MANITOWOCICE.COM/SALES/SALES-LOCATORS



▶ FROM PENTAIR WATER SOLUTIONS

+1(920)682.0161 FAX +1(920)683.7589
manitowocice.com

Our customized solutions provide much more than just temporary enhancements. Backed by decades of experience in the industry, our products are relentlessly reliable, built to last and withstand the daily pressures of food service demands. And that's the same dependability reflected in our own strong support network, providing the consistent service you need at every stage of your business.

Engineered for Ease • manitowocice.com