



Item: _____

Quantity: _____

Project: _____

Thermostatic Griddle

Delux Series

Models: RDTG-24 RDTG-36 RDTG-48 RDTG-60 RDTG-72

Gas Type: Natural LP

Elevation (if above 2000 ft.): _____



RDTG-36

Standard Features

- Fully welded frame with lifetime warranty
- 1,200°F mineral wool insulation
- 11" high- perfect height for refrigerated base
- Large 1½ gallon capacity S/S grease can (2 ea on 60" & 72" units)
- Stainless steel sides and front valve cover
- Aeration panels between the burners for added efficiency
- Stainless Steel "U" shaped burner every 12", rated at 30,000 BTU/hr
- Energy saving thermostat is adjustable from 150°-450° F
- 1" thick griddle plate with polished cooking surface
- Thermo control to operate every burner
- 4" wide S/S grease trough with large drain opening for easy cleaning
- Stainless steel tubing for burners and pilots
- 4" high adjustable heavy duty legs included

Options and Accessories

- Grooved griddle (specify width: _____")
 - Chrome griddle plate
 - Belly Bar
 - Stainless Steel Equipment Stand
 - Knock Down All Welded
- Size**
- 12" 18" 24" 30" 36" 48" 60" 72"
 - 5" swivel casters (set of four - 2 locking)
 - 5" swivel casters (set of four - 2 locking) (60" and 72" stands)



2 YEAR LIMITED, PARTS AND LABOR WARRANTY

Thermostatic Griddle

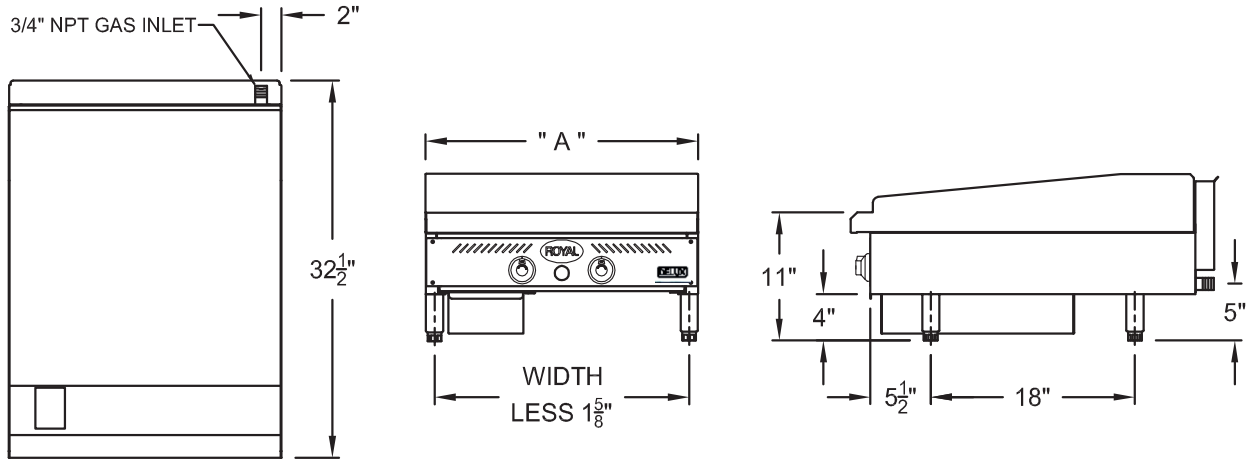

Model Number	Width (A)	Number of Thermostats	Number of Burners	Total BTU	Ship Weight
RDTG-24	24"	2	2	60,000	215 lbs.
RDTG-36	36"	3	3	90,000	300 lbs.
RDTG-48	48"	4	4	120,000	350 lbs.
RDTG-60	60"	5	5	150,000	640 lbs.
RDTG-72	72"	6	6	180,000	745 lbs.

Notes:

Gas Connection:

3/4" NPT on the right hand rear of the appliance.

The pressure regulator (supplied) is to be connected by the installer.

Specify type of gas and altitude, if over 2,000 feet, when ordering.

Gas Pressure:

5" W.C.	Natural Gas
10" W.C.	Propane

Clearances:

	Combustible	Non-Combustible
Rear	6"	0"
Sides	4"	0"

Due to continuing product development to ensure best possible performance, these specifications are subject to change without prior notification.

Royal Range of California, Inc.
 3245 Corridor Dr. • Eastvale, CA 91752 • (800) 769-2414 • (951) 360-1600
 Fax: (951) 360-7500 • www.royalranges.com • sales@royalranges.com