



Item: _____

Quantity: _____

Project: _____

Delux Series

Models: RDMG-24 RDMG-36 RDMG-48 RDMG-60 RDMG-72



RDMG-36

Gas Type: Natural LP

Elevation (if above 2000 ft.): _____

Standard Features

- Fully welded frame with lifetime warranty
- 1,200°F mineral wool insulation
- 11" high, Low Profile
- Large 1½ gallon capacity stainless steel grease can (2 ea on 60" & 72" units)
- Compact heavy gauge chassis for long life
- Stainless steel sides, front valve cover and ledge
- Aeration panels between the burners for added efficiency
- Stainless Steel "U" shaped burner every 12" rated at 30,000 BTU/hr
- 3/4" thick griddle plate with polished cooking surface
- Manual control for each burner
- 4" wide S/S grease trough with large drain opening for easy cleaning
- Stainless steel tubing for pilots
- 4" high adjustable heavy duty legs included

Options and Accessories

- 1" thick griddle plate
- Grooved griddle (specify width: _____")
- Chrome griddle plate
- Belly Bar
- Stainless Steel Equipment Stand
 - Knock Down All Welded
- Size
 - 12" 18" 24" 30" 36" 48" 60" 72"
 - 5" swivel casters (set of four - 2 locking)
 - 5" swivel casters (set of six - 3 locking) (60" and 72" models)

2 YEAR LIMITED, PARTS AND LABOR WARRANTY



Manual Griddle

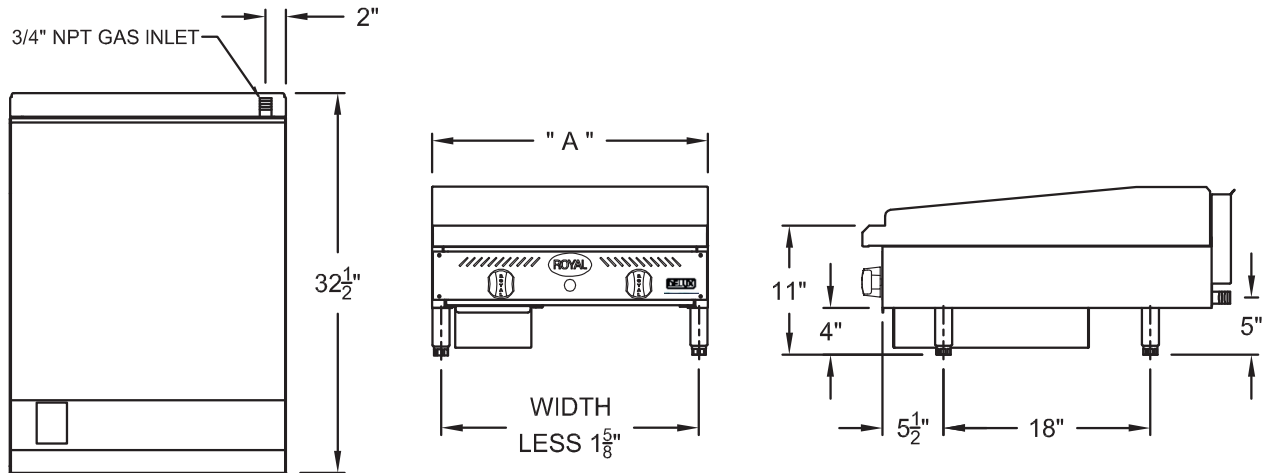

Model Number	Width (A)	Number of Burners	Total BTU	Ship Weight
RDMG-24	24"	2	60,000	210 lbs.
RDMG-36	36"	3	90,000	290 lbs.
RDMG-48	48"	4	120,000	370 lbs.
RDMG-60	60"	5	150,000	460 lbs.
RDMG-72	72"	6	180,000	540 lbs.

Notes:

- Each burner is rated at 30,000 BTU/hr

Gas Connection:

3/4" NPT on the right hand rear of the appliance.

The pressure regulator (supplied) is to be connected by the installer.

Specify type of gas and altitude, if over 2,000 feet, when ordering.

Gas Pressure:

5" W.C.	Natural Gas
10" W.C.	Propane

Clearances:

	Combustible	Non-Combustible
Rear	4"	0"
Sides	15"	0"

Due to continuing product development to ensure best possible performance, these specifications are subject to change without prior notification.

Royal Range of California, Inc.
 3245 Corridor Dr. • Eastvale, CA 91752 • (800) 769-2414 • (951) 360-1600
 Fax: (951) 360-7500 • www.royalranges.com • sales@royalranges.com