

Project:

PRELIMINARY



[Scan for more info!](#)  
Owners manual  
Install guide

## iN2-TK2P

ProFusion Beverage  
Dispensing Tapping Kit



### N<sub>2</sub> and CO<sub>2</sub> beverages on tap

- The iN2-TK2P tapping kit is designed to convert your existing kegorator or back bar cooler into a ProFusion beverage dispensing system.
- The ProFusion system uses one cold keg of cold brew coffee, tea or your craft beverage of choice and dispenses two different style beverages from a single keg (Nitrogenated and Still Beverage on Tap).
- Simple set-up configuration: One keg connection, two outlets. One gas connection, feeds both the system and keg (each with their own pressure control).
- High visibility and easy accessible particulate filter

### Specifications

iN2-2P Specifications:

- 10.5"W x 4.5"D x 12.75"H includes top and bottom mounting bracket
- One gas inlet, dual gas control for keg and injector pressures
- One product keg inlet, two product outlets
- Built in stainless steel particulate filter, 50 micron, washable and reusable
- Must be located in a refrigerated space within five feet of dispensing tower

iN2-V2 two tap, column tower specifications:

- Two stainless steel faucets
- Insulated and air cooled
- 3/8" barrier hoses
- Supplied with fittings and hose kit

Tapping Kit specifications:





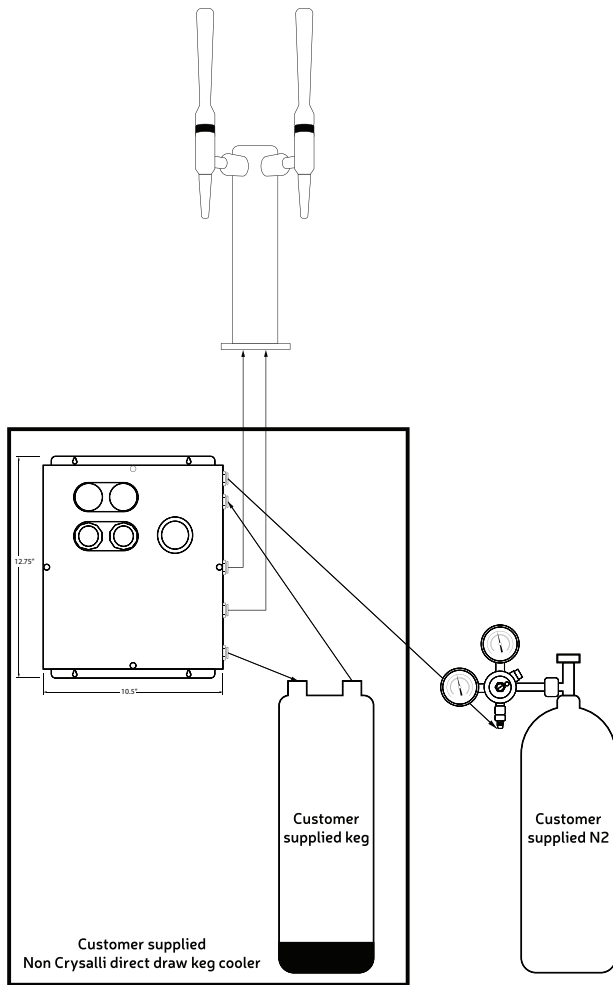

- N<sub>2</sub> primary regulator included
- Available with premix tank quick connect couplers or with D style keg couplers

## Tapping kit configurations:

- **iN2-TK2P-P**  
iN2 tapping kit; one iN2 device, two product iN2 draft tower, fittings, hoses, premix tank connector.
- **iN2-TK2P-D**  
iN2 tapping kit; one iN2 device, two product iN2 draft tower, fittings, hoses, D style keg connector.



## Accessories:

- **CR-PMT-5G**  
5 gallon premix tank  

- **CR-PMT-2.5G**  
2.5 gallon premix tank  

- **1-2Coldbrew**  
Cleaning and sanitizing kit for cold brew systems  

- **Gas Ball Lock**  
Disconnects for premix tank  

- **Liquid Ball Lock**  
Disconnects for premix tank  

- **Keg Coupler**  
D Style stainless steel  

- **CR-CUSTAP**  
Custom tap handles. Contact factory for options and details.

